



**HAL**  
open science

## Horloges atomiques et applications

Sebastien Bize

► **To cite this version:**

| Sebastien Bize. Horloges atomiques et applications. Master. 2011. sfo-00658677

**HAL Id: sfo-00658677**

**<https://hal-sfo.ccsd.cnrs.fr/sfo-00658677>**

Submitted on 10 Jan 2012

**HAL** is a multi-disciplinary open access archive for the deposit and dissemination of scientific research documents, whether they are published or not. The documents may come from teaching and research institutions in France or abroad, or from public or private research centers.

L'archive ouverte pluridisciplinaire **HAL**, est destinée au dépôt et à la diffusion de documents scientifiques de niveau recherche, publiés ou non, émanant des établissements d'enseignement et de recherche français ou étrangers, des laboratoires publics ou privés.



Systèmes de Référence Temps-Espace

# Horloges Atomiques et Applications



Sébastien BIZE  
SYRTE, Observatoire de Paris  
61 avenue de l'Observatoire, 75014 Paris, France  
sebastien.bize@obspm.fr

*L'optique à Paris  
17 novembre 2011  
Ecole Normale Supérieure, Paris*



## Plan de l'exposé

- Généralités sur la mesure du temps
- Généralités sur les horloges atomiques
- Horloges de grande exactitude
  - Fontaines atomiques
  - Horloges optiques
  - Laser ultra stables
  - Méthodes de comparaison
- Tests fondamentaux à l'aide d'horloges

# Une manière universelle de percevoir le temps

- En observant la périodicité d'un phénomène naturel: la rotation de la Terre
  - La succession jour/nuit permet de compter les jours qui passent

- De manière plus fine
  - Gnomon, cadran solaire

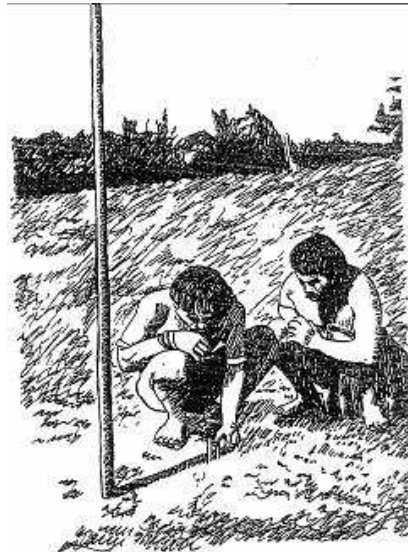

- Beaucoup plus fine
  - Jusqu'en 1967, la seconde du Système Internationale (SI) est basée sur le mouvement de la Terre
- Le principe de l'observation d'un phénomène périodique reste valable pour les horloges les plus modernes

# Principe de mesure d'une durée ou intervalle de temps

- Observation et comptage d'un phénomène périodique

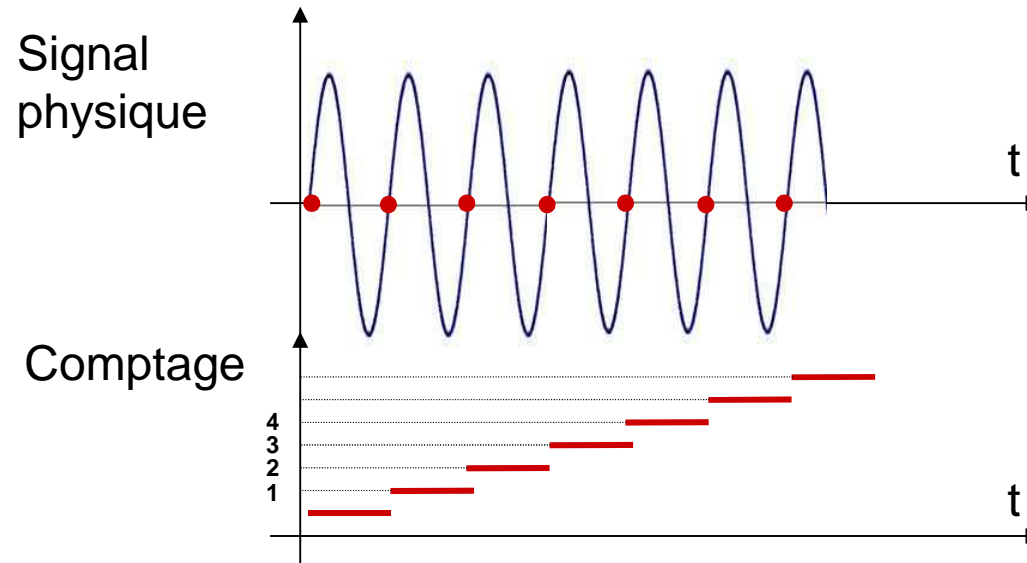

- Qualité de mesure d'un intervalle de temps
  - → stabilité du phénomène périodique
  - → nombre de périodes mesurées

# Influence de la fréquence d'oscillation

- Une fréquence plus élevée permet une subdivision plus fine d'un intervalle de temps donné

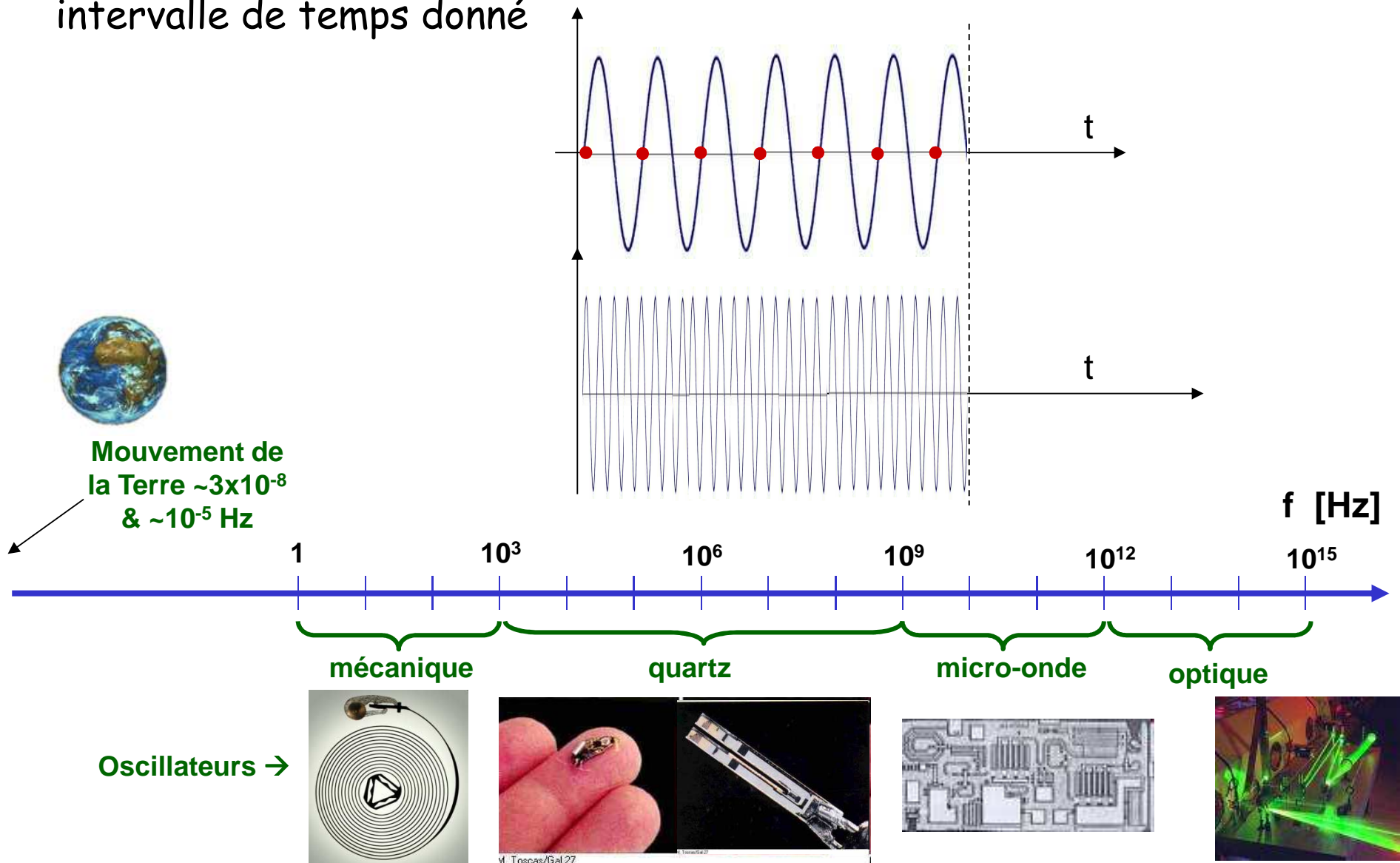

# Imperfection des oscillateurs

## ■ Problème



- La fréquence dépend de la géométrie, des dimensions et de beaucoup d'autres caractéristiques physiques
- Sujet au vieillissement, à l'usure, à l'influence de paramètres extérieurs
- → Pas de caractère universel

## ■ Solution

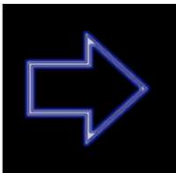

- Stabiliser la fréquence de l'oscillateur sur une référence « absolue » : une transition atomique

# L'atome : une référence universelle et (quasi) parfaite

- L'atome a des niveaux d'énergie quantifiés

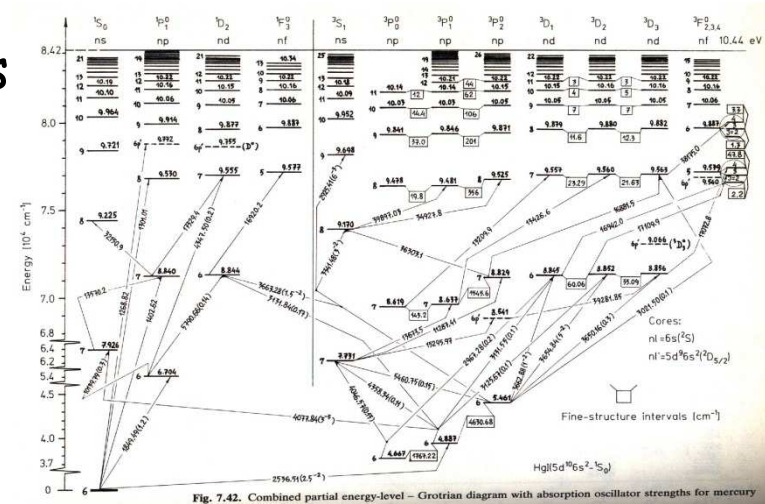

- A la différence d'énergie entre deux niveaux correspond une fréquence via la relation de Planck

$$\hbar\omega_{ef} = h\nu_{ef} = E_e - E_f$$

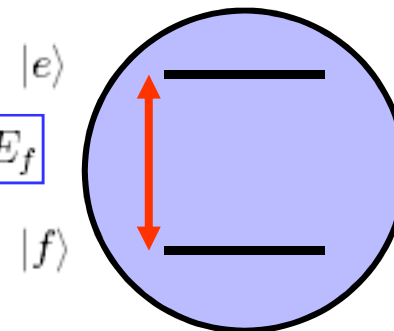

- Les fréquences de Bohr d'un atome non perturbé sont parfaitement stables et universelles. Elles ne dépendent *a priori* que des constantes fondamentales.
- Deux atomes de la même espèce sont « identiques »
- « Ils ne s'usent pas »



# Principle of atomic clocks

## Building blocks of an atomic clock

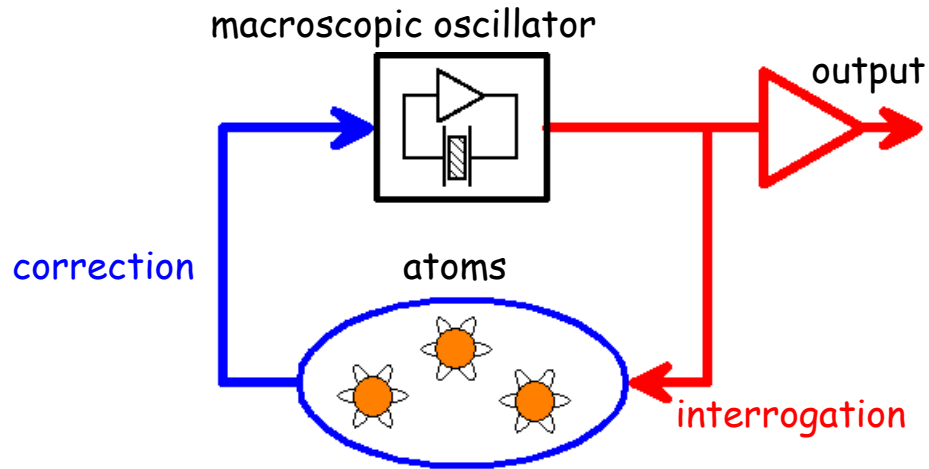

$$\omega(t) = \omega_{ef} \times (1 + \varepsilon + y(t))$$

$\varepsilon$ : fractional frequency offset

Accuracy: overall uncertainty on  $\varepsilon$

$y(t)$ : fractional frequency fluctuations

Stability: statistical properties of  $y(t)$ , characterized by the Allan variance  $\sigma_y^2(\tau)$

Can be done with microwave or optical frequencies, with neutral atoms, ions or molecules

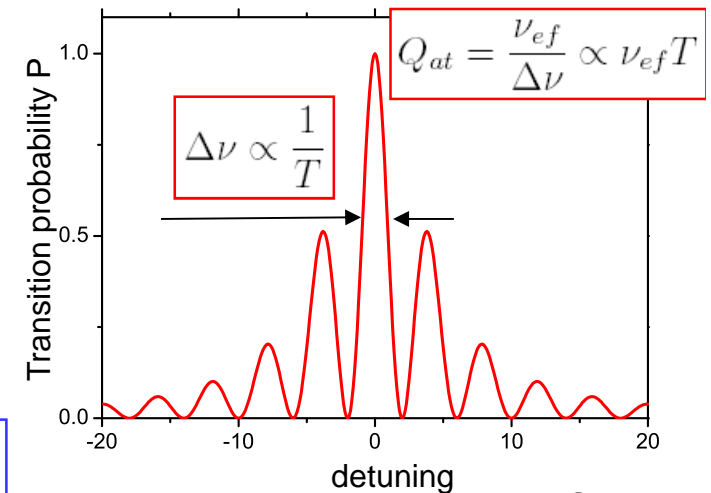
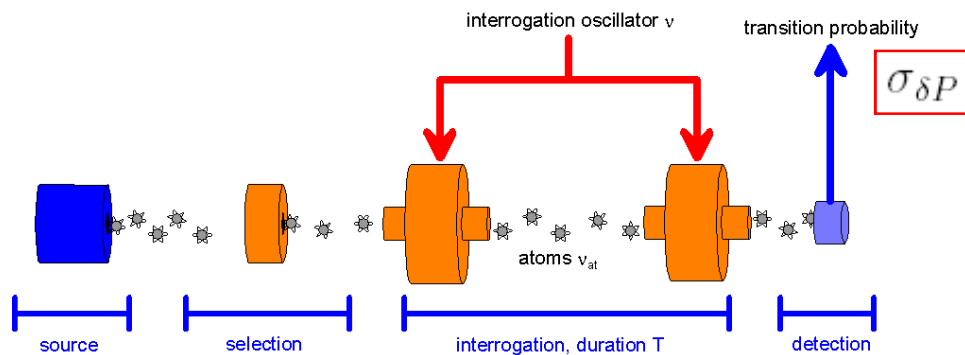

Fractional frequency instability:

$$\sigma_y(\tau) \propto \frac{\sigma_{\delta P}}{Q_{at}} \sqrt{\frac{T_c}{\tau}}$$

# Une grande variété d'horloges atomiques...

Performances

*Horloges commerciales :  
industrie, laboratoires, GNSS, ...*

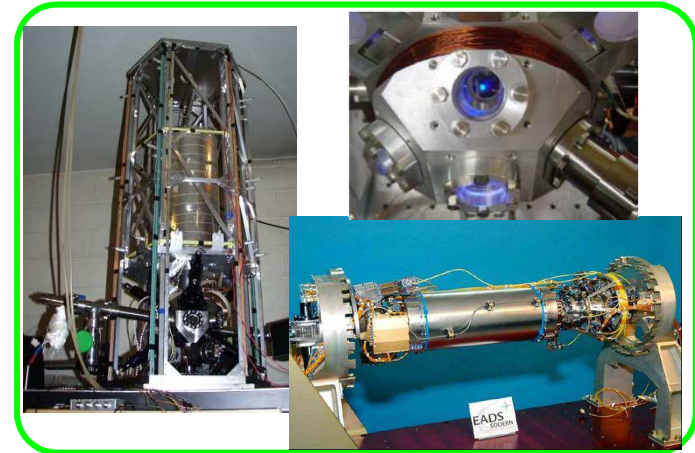
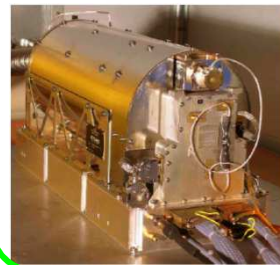

*Horloges de laboratoire :  
Métrologie et physique  
fondamentales*

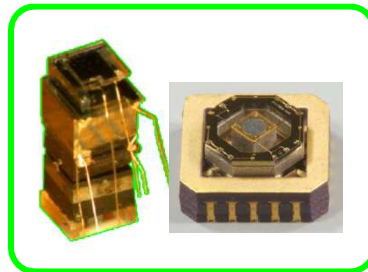

*Horloges miniatures :  
Industrie, récepteurs GPS/GALILEO*

Volume

1 cm<sup>3</sup>

1 dm<sup>3</sup>

1 m<sup>3</sup>

## ...pour de nombreuses applications

### Métrologie fondamentale

- Échelles de temps atomique, temps légal (horloge parlante 36 99, réseau hertzien, NTP, ...)
- Redéfinition des unités



### Tests de physique fondamentale

- Relativité Générale : décalage gravitationnel vers le rouge
- Invariance locale de Lorentz et de position
- Variation des constantes fondamentales

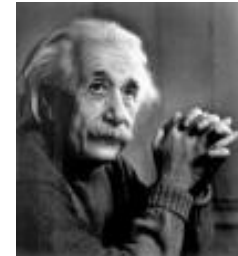

### Navigation et Positionnement

- 1ns  $\Leftrightarrow$  30 cm
- Global Navigation Satellite Systems (GNSS): GPS (USA), GLONASS (Russie), GALILEO (Europe), BEIDOU/COMPASS (Chine), GINSS (Inde)



### Synchronisation des réseaux de télécommunication

### Astronomie

- Very Long Baseline Interferometry (VLBI), Astrocomb

### Géophysique

- Rotation de la Terre
- Cartographie de potentiel de gravitation

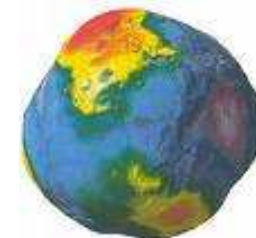
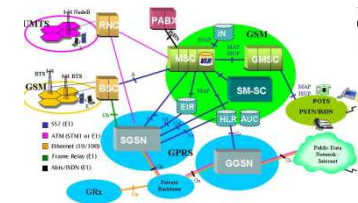

# Atomic fountain clocks

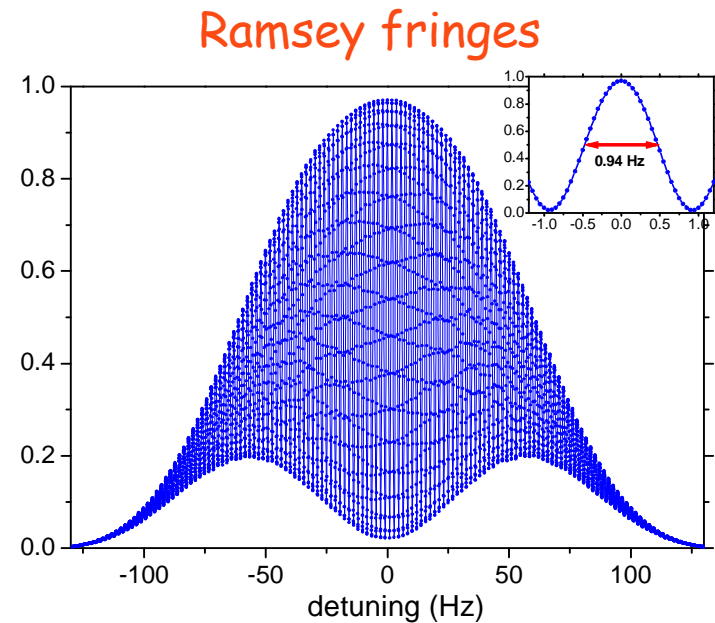
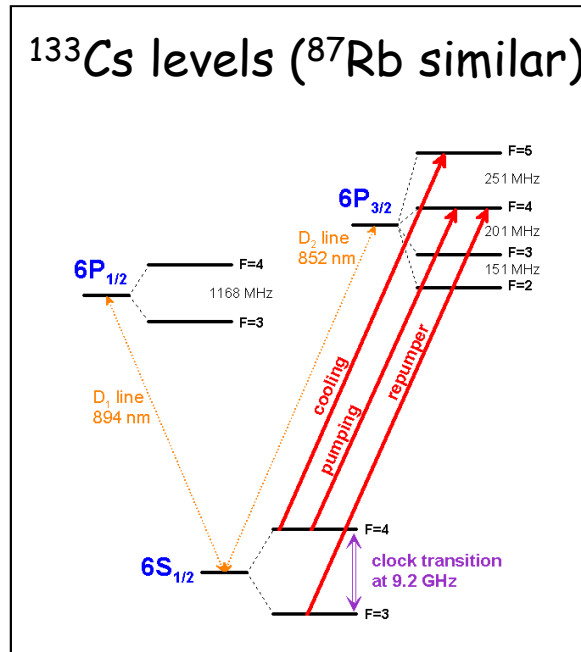
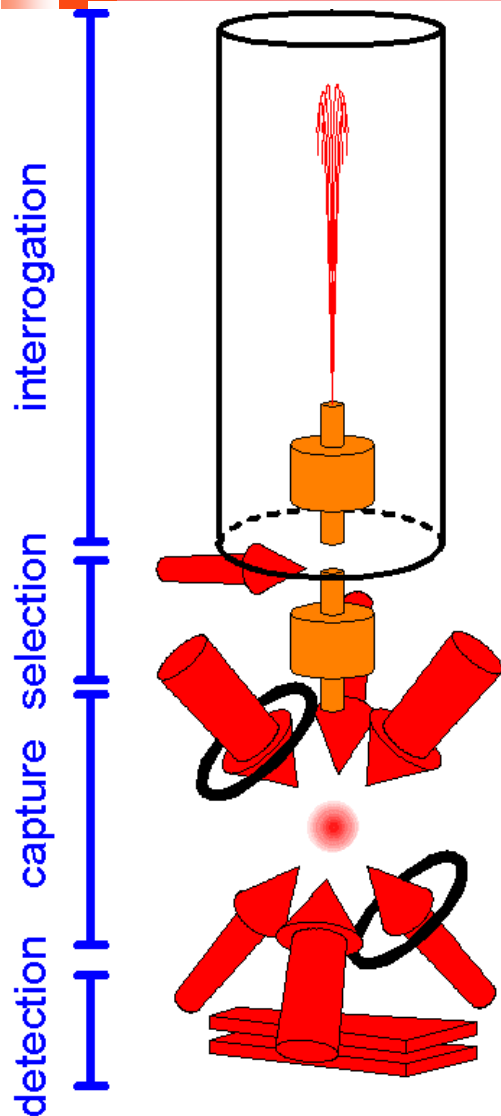

Atomic quality factor:

$$Q_{at} = \nu_{ef} / \Delta\nu \simeq 9.8 \times 10^9$$

Best frequency stability (~ Quantum Projection Noise limited):  $1.6 \times 10^{-14}$  @1s

Best accuracy:  $2.4 \times 10^{-16}$

## ■ Second of the International System of Units (SI)

« The second is the duration of 9 192 631 770 periods of the radiation corresponding to the transition between the two hyperfine levels of the ground state of the caesium-133 atom »

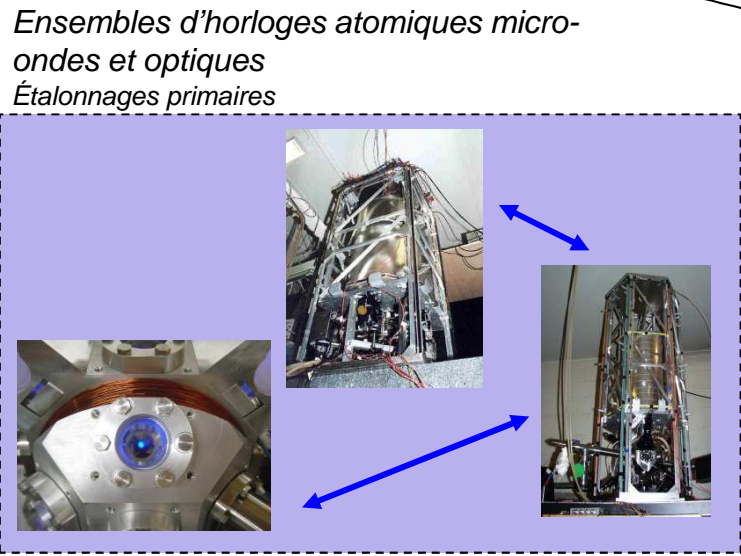
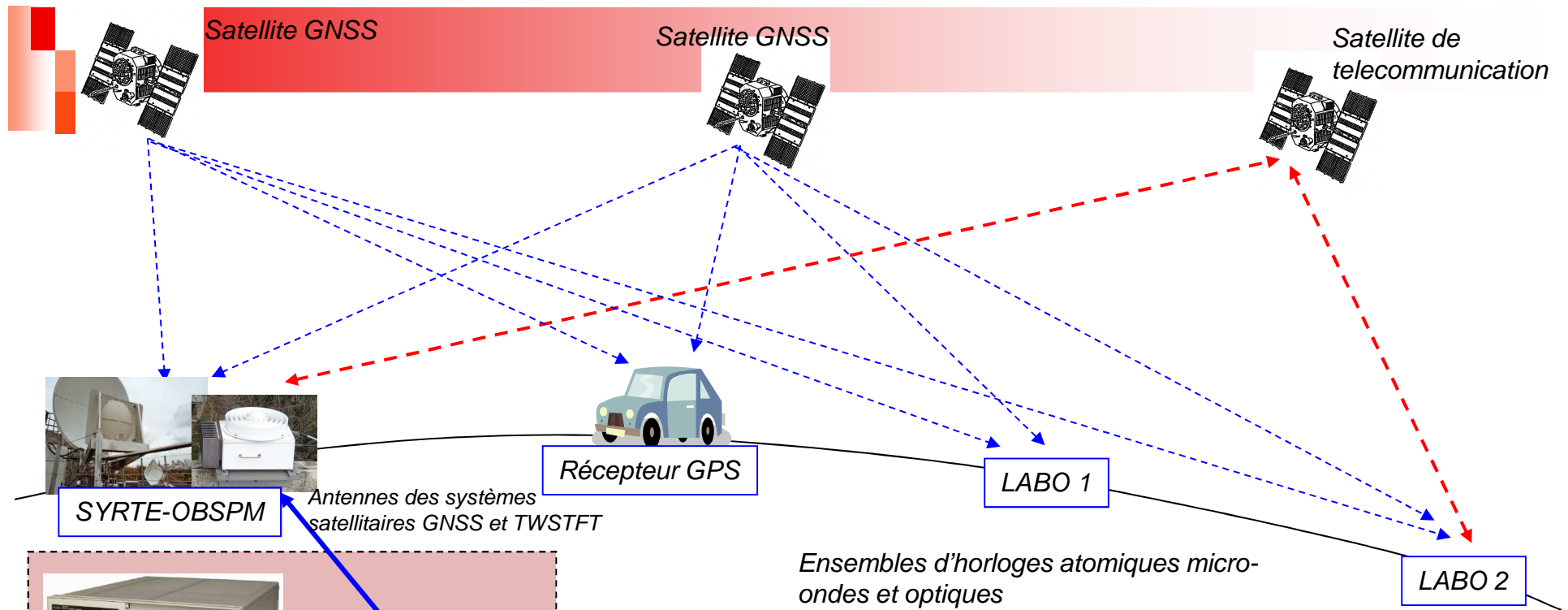

Ensemble d'horloges commerciales  
 Comparaisons et algorithmes d'échelle de temps  
 Horloge parlante  
 Diffusion Temps Légal Français

# Motivations for developing optical clocks

Stability of an atomic clock :

$$\sigma_y(\tau) \propto \frac{\sigma_{\delta P}}{Q_{at}} \sqrt{\frac{T_c}{\tau}}$$

$$Q_{at} = \frac{\nu_{ef}}{\Delta\nu} \propto \nu_{ef} T$$

Quantum limited stability :

$$\sigma_y(\tau) = \frac{1}{\pi Q_{at}} \times \frac{1}{\sqrt{N_{det}}} \times \sqrt{\frac{T_c}{\tau}}$$

Microwave transition :  $\nu_{ef} \sim 10$  GHz, optical transition :  $\nu_{ef} = c/\lambda \sim 10^{14}$  Hz

Example #1: cycle  $T_c \sim 1$  s, linewidth  $\sim 1$  Hz et  $\sigma_{\delta p} \sim 10^{-4}$  :

Microwave :  $\sigma_y = 10^{-14}$  @1s

Optical :  $\sigma_y = 10^{-18}$  @1s

In practice, best reported stabilities

$\sigma_y = \sim$  few parts in  $10^{15}$  @1s

Example #2: cycle  $T_c \sim 1$  s, linewidth  $\sim 1$  Hz et  $N_{det} \sim 1$  (1 atom !):

Optical :  $\sigma_y = 3 \times 10^{-15}$  @1s

→ Better stability implies better resolution to evaluate systematic shifts

→ Many systematic shifts are much smaller as compared to microwave clocks

→  **$10^{-17}$  or better is within reach provided a solution is found for the effects of external motion**

$$\delta\omega_{Doppler} = \vec{k} \cdot \vec{v} \sim \omega \times \frac{v}{c}$$

$$\frac{\delta\omega_{Doppler}}{\omega} \sim \frac{v}{c}$$

# Motional effects on confined atoms: Lamb-Dicke regime

- Consider an atom spatially confined to much less than the wavelength of the incoming photon

$$\Delta x_{at} \ll \frac{\lambda}{4\pi}$$

- In momentum space, the atomic wave-function is such that:

$$\Delta p_{at} \cdot \Delta x_{at} > \hbar/2 \quad \text{or} \quad \Delta k_{at} \cdot \Delta x_{at} > 1/2$$

- This implies that:  $\Delta k_{at} > \frac{1}{2\Delta x_{at}} \gg \frac{2\pi}{\lambda} = k$  or  $\Delta k_{at} \gg k$

- the size of the wave-function in momentum space is large compared to the photon momentum
- The shift in momentum space implied by momentum conservation induces a minor modification of the wave-packet
- Small shift of the resonant frequency when the energy conservation is applied

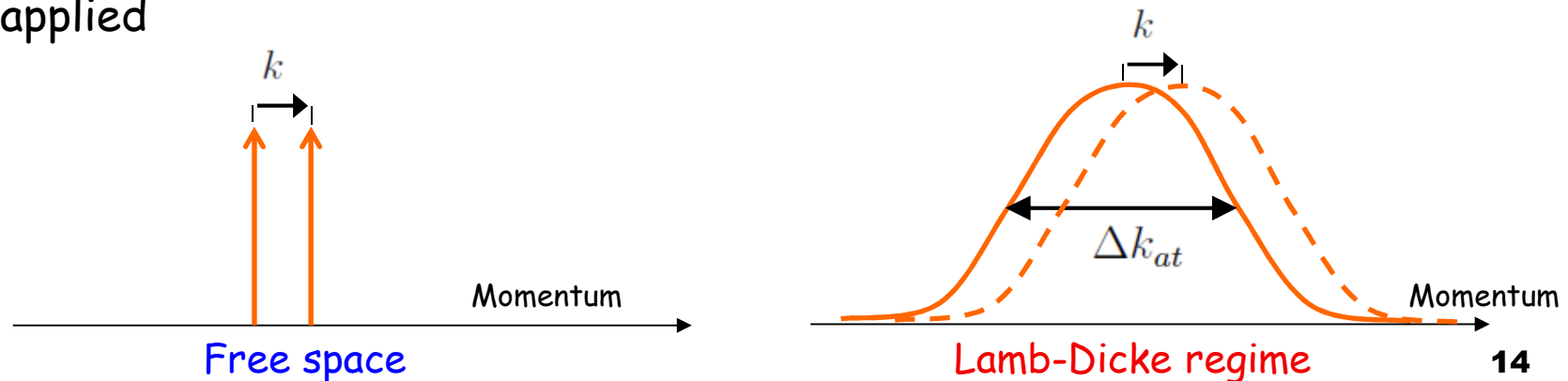

# Optical lattice clocks

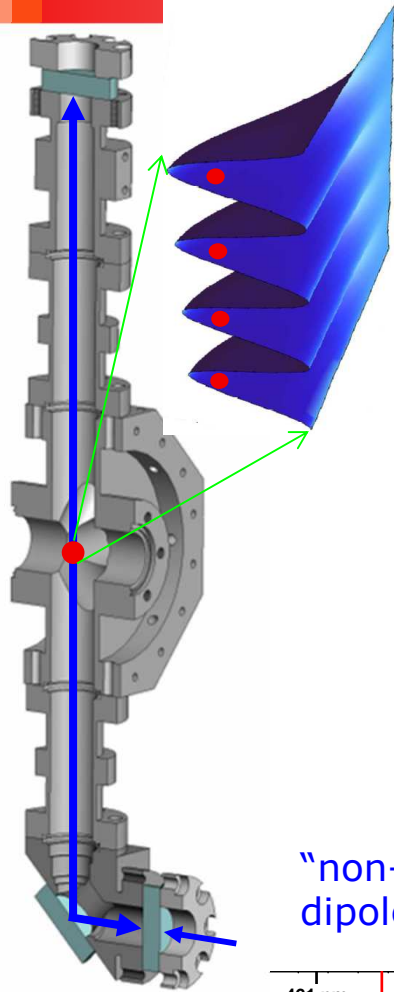

"non-perturbing"  
dipole lattice trap

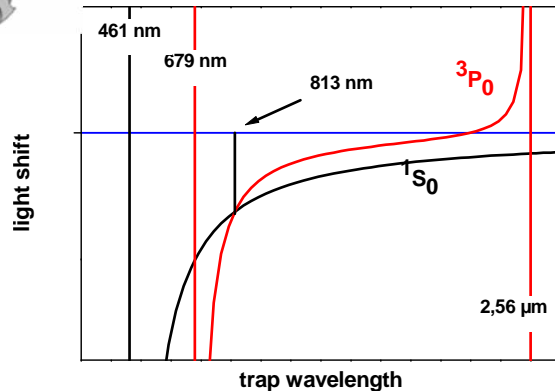

$^{87}\text{Sr}$  (Yb, Hg similar)

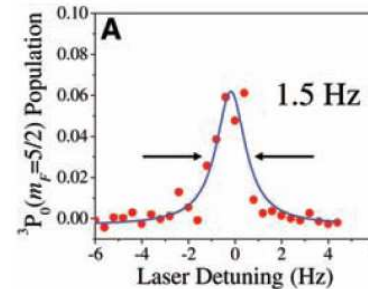
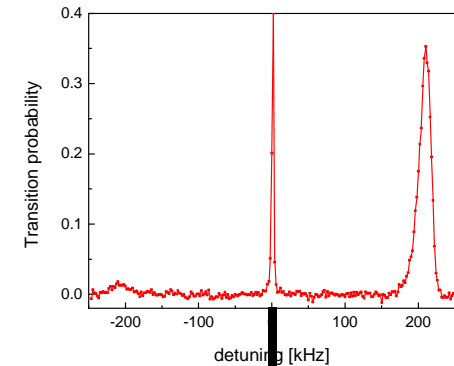
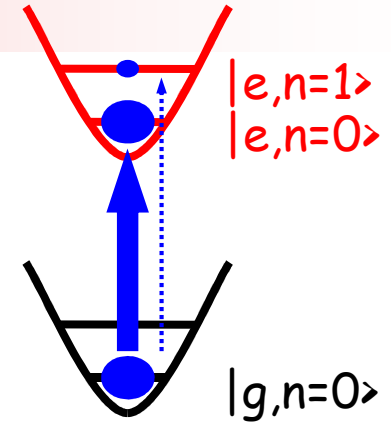
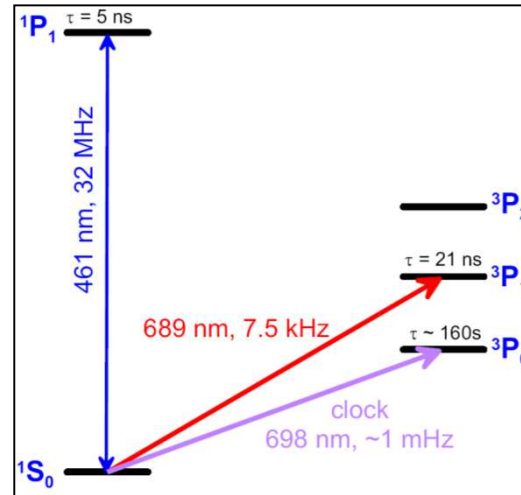

Atomic quality factor:  $\sim 2.8 \times 10^{14}$

Best frequency stability:  $\sim 2 \times 10^{-15}$  @ 1s

Best accuracy :  $\sim 1.4 \times 10^{-16}$

→ Large room for improving stability and accuracy



# Ultra stable probe light @265.6 nm

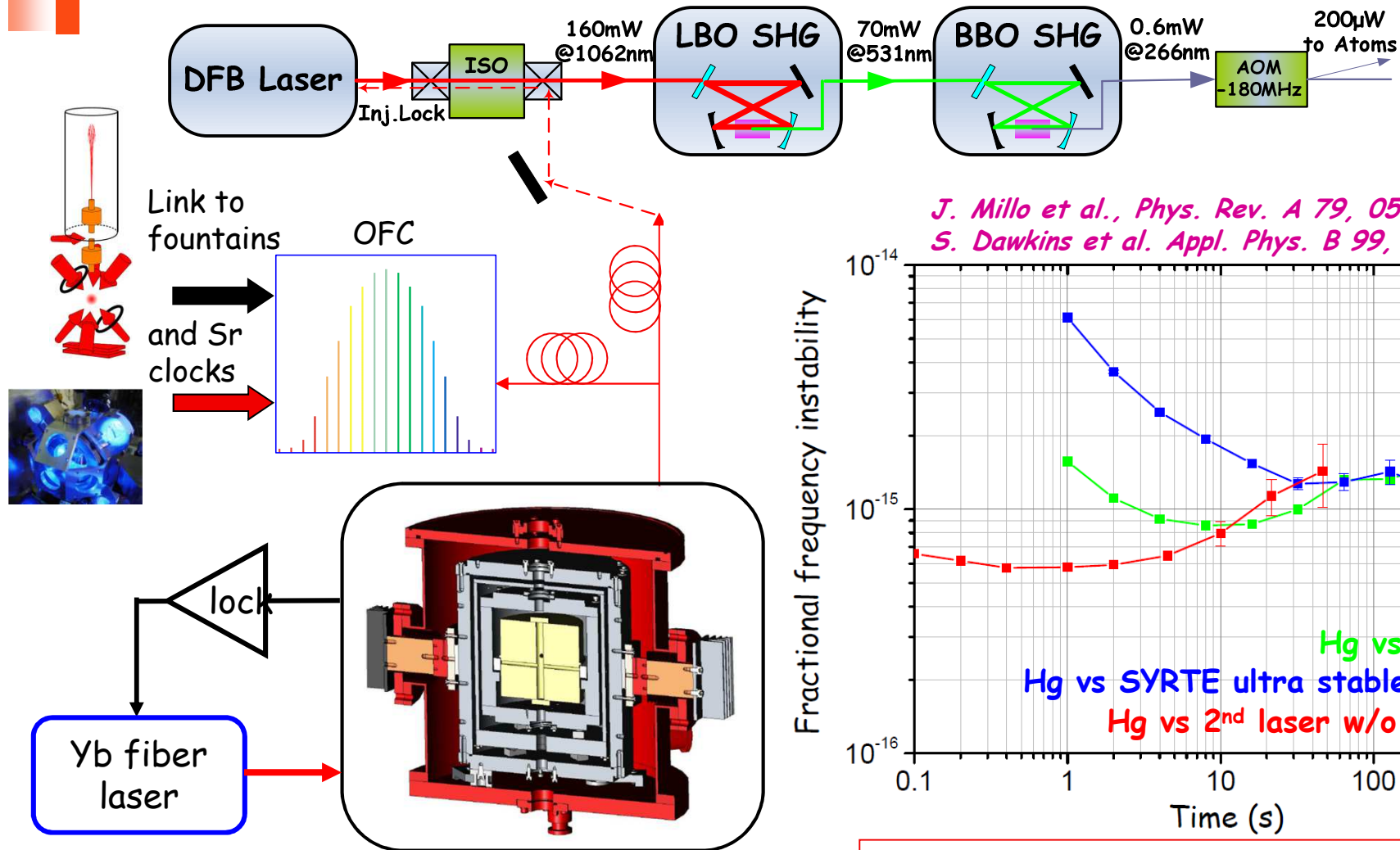

*J. Millo et al., Phys. Rev. A 79, 053829 (2009)*  
*S. Dawkins et al. Appl. Phys. B 99, 41 (2010)*

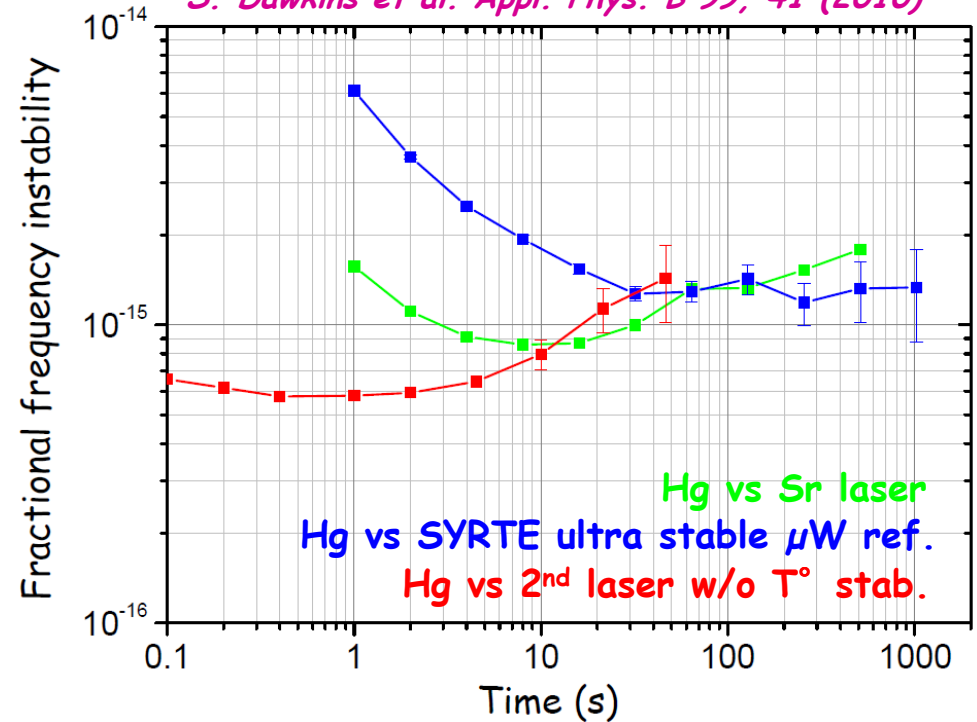

- Vertically mounted, low vibration sensitivity
- 10cm length, Finesse  $\sim 850000$
- FS mirrors for thermal noise  $< 10^{-15}$
- Heavy passive thermal shielding ( $\tau > 4$  days)

- → Flicker floor  $\sim 4 \times 10^{-16}$  each
- → Linewidth  $\sim 170$  MHz
- →  $\sim -20$  mHz/s drift ( $-7 \times 10^{-17}/s$ )
- → Months continuous operation

# Output of a mode-locked Laser

## Ideal train of light pulses in time domain

*T. W. Hänsch, Rev. Mod. Phys. 78, 1297 (2006)*

*J. L. Hall, Rev. Mod. Phys. 78, 1279 (2006)*

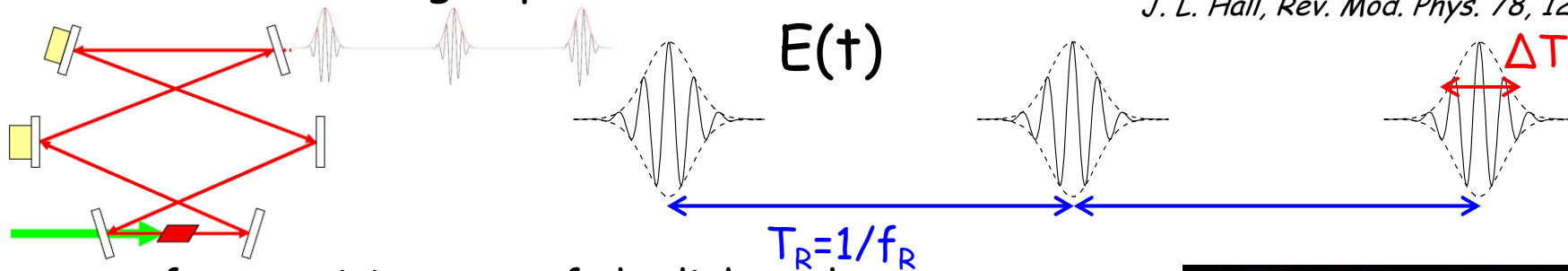

□  $f_R$ : repetition rate of the light pulses

## Pulse train inside the laser cavity with:

$$v_g \neq v_\phi$$

Carrier envelop phase shift

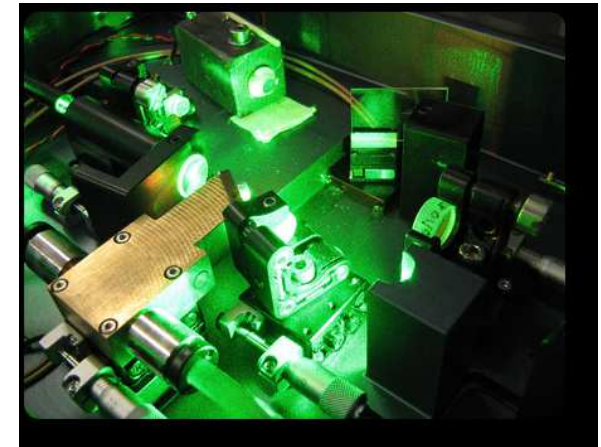
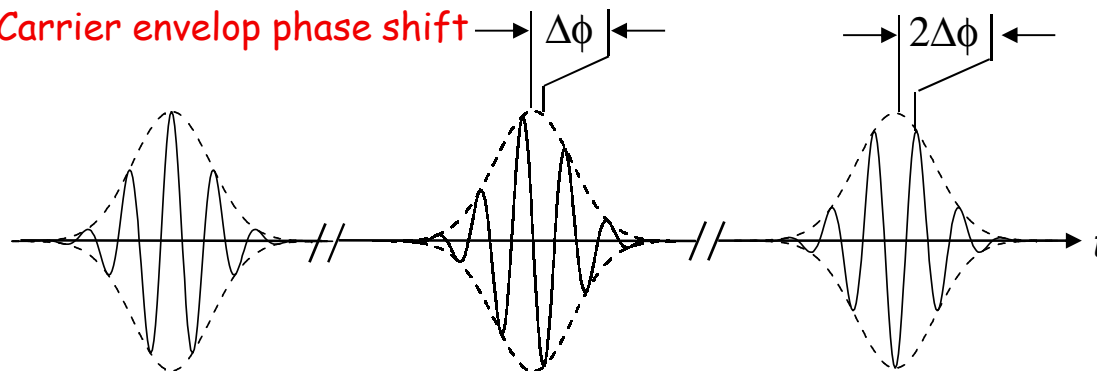

## Frequency domain

□ Components are phase coherent

□ Fourier limit:  $\Delta T \cdot \Delta \nu \geq 1/4\pi$

□ Comb shifted by  $f_0$

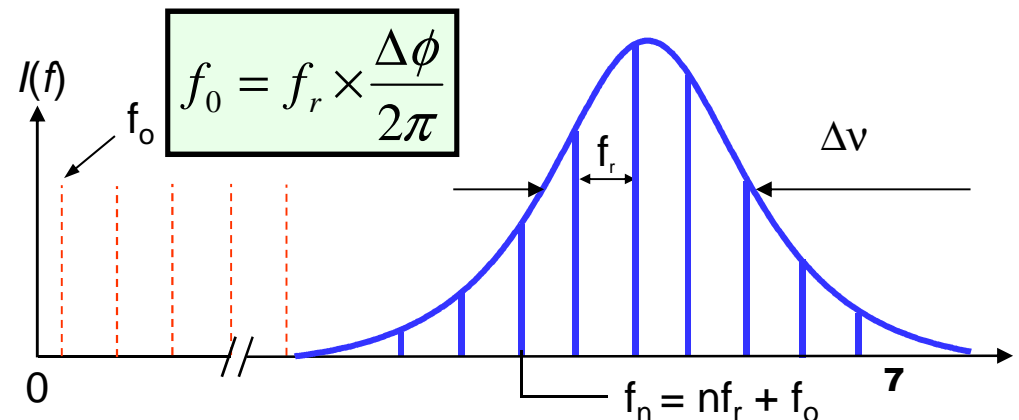

# Optical frequency combs

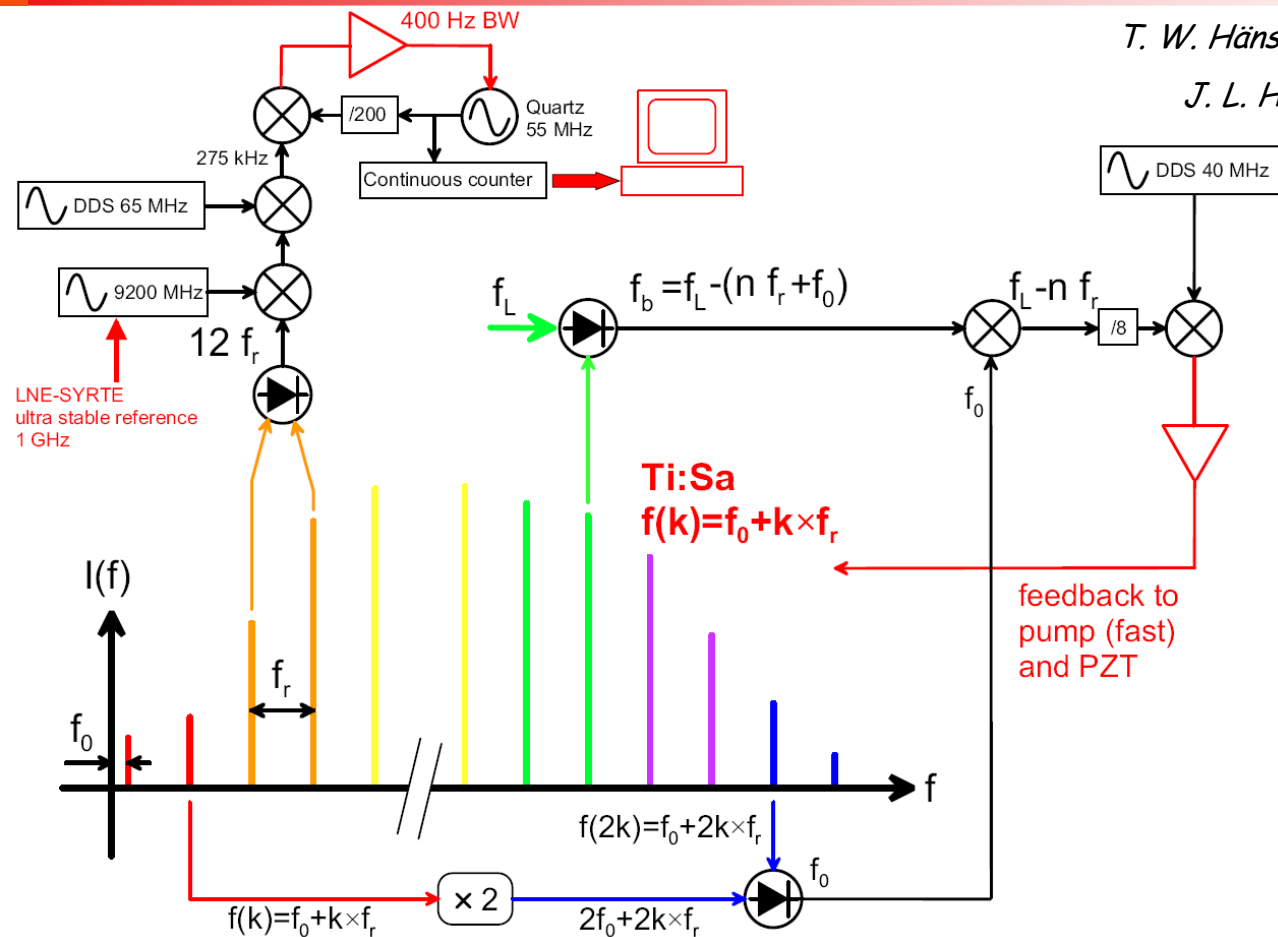

*T. W. Hänsch, Rev. Mod. Phys. 78, 1297 (2006)*

*J. L. Hall, Rev. Mod. Phys. 78, 1279 (2006)*

- The Optical Frequency Comb can be used in many different ways depending on the goal
- Reliable optical frequency combs are now available
- → Essential for making optical clocks useful

# Coherent optical fiber link

- "Easy" manipulation/measurement of optical carrier signals opens to possibility of new and better frequency and time transfer methods
- Coherent fiber link: the transmitted signal is the phase of the optical carrier
  - Largely surpasses existing satellite methods
  - Adapted to the new generation of optical clocks
- Principle of the link: heterodyne Michelson interferometer

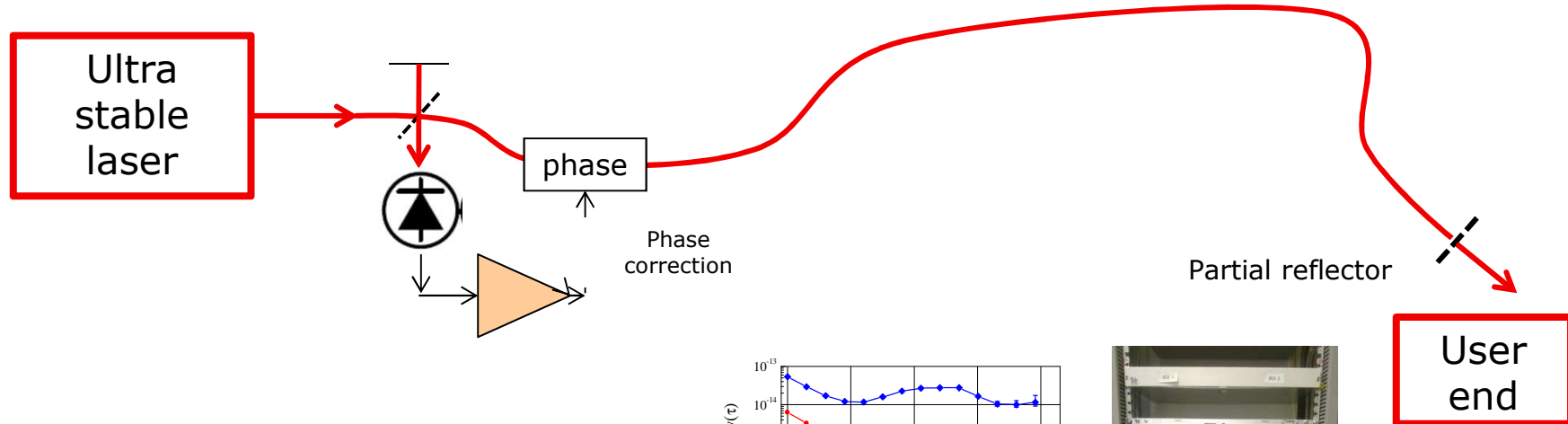

- Feasibility very well established

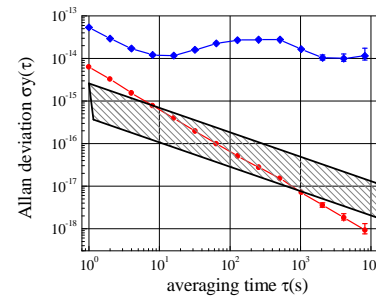

# Fundamental Tests using Atomic Clocks

- General Relativity (GR) is one the corner stone of modern physics
- Description of space and time in relation with gravity is key to GR
- ➔ Clocks and highly stable oscillators (frequency related to the length macroscopic objects) are useful tools to test GR
- GR and the Equivalence Principle (EP) is questioned by unification theories
- Examples of GR/EP tests with clocks

- Test for variation of fundamental constants with time and gravitational potential

$$\nu_A = R_\infty c \times f_A \left( \alpha, \frac{m_e}{\Lambda_{\text{QCD}}}, \frac{m_q}{\Lambda_{\text{QCD}}}, \dots \right)$$

*Electroweak interaction (QED)*

*Strong interaction (QCD)*

$$\frac{\nu_A}{\nu_B} = \frac{f_A \left( \alpha, \frac{m_e}{\Lambda_{\text{QCD}}}, \frac{m_q}{\Lambda_{\text{QCD}}}, \dots \right)}{f_B \left( \alpha, \frac{m_e}{\Lambda_{\text{QCD}}}, \frac{m_q}{\Lambda_{\text{QCD}}}, \dots \right)}$$

- Measurement of the gravitational redshift

# Stability of constants tested with clocks

$$\frac{d}{dt} \ln \left( \frac{\nu_{\text{Rb}}}{\nu_{\text{Cs}}} \right) = (-2.0 \pm 1.2) \times 10^{-16} \text{ yr}^{-1} = -0.49 \frac{d}{dt} \ln(\alpha) - 0.025 \frac{d}{dt} \ln(m_q / \Lambda_{\text{QCD}})$$

$$\frac{d}{dt} \ln \left( \frac{\nu_{\text{H}}}{\nu_{\text{Cs}}} \right) = (-32 \pm 63) \times 10^{-16} \text{ yr}^{-1} = -2.83 \frac{d}{dt} \ln(\alpha) + 0.039 \frac{d}{dt} \ln(m_q / \Lambda_{\text{QCD}}) - \frac{d}{dt} \ln(m_e / \Lambda_{\text{QCD}})$$

$$\frac{d}{dt} \ln \left( \frac{\nu_{\text{Sr}}}{\nu_{\text{Cs}}} \right) = (-7 \pm 18) \times 10^{-16} \text{ yr}^{-1} = -2.77 \frac{d}{dt} \ln(\alpha) + 0.039 \frac{d}{dt} \ln(m_q / \Lambda_{\text{QCD}}) - \frac{d}{dt} \ln(m_e / \Lambda_{\text{QCD}})$$

$$\frac{d}{dt} \ln \left( \frac{\nu_{\text{Hg}^+}}{\nu_{\text{Cs}}} \right) = (3.7 \pm 3.9) \times 10^{-16} \text{ yr}^{-1} = -6.03 \frac{d}{dt} \ln(\alpha) + 0.039 \frac{d}{dt} \ln(m_q / \Lambda_{\text{QCD}}) - \frac{d}{dt} \ln(m_e / \Lambda_{\text{QCD}})$$

$$\frac{d}{dt} \ln \left( \frac{\nu_{\text{Dy}}}{\nu_{\text{Cs}}} \right) = (-4 \pm 3.9) \times 10^{-8} \text{ yr}^{-1} = 1.5 \times 10^7 \frac{d}{dt} \ln(\alpha) + 0.039 \frac{d}{dt} \ln(m_q / \Lambda_{\text{QCD}}) - \frac{d}{dt} \ln(m_e / \Lambda_{\text{QCD}})$$

$$\frac{d}{dt} \ln \left( \frac{\nu_{\text{Yb}^+}}{\nu_{\text{Cs}}} \right) = (-7.8 \pm 14) \times 10^{-16} \text{ yr}^{-1} = -1.95 \frac{d}{dt} \ln(\alpha) + 0.039 \frac{d}{dt} \ln(m_q / \Lambda_{\text{QCD}}) - \frac{d}{dt} \ln(m_e / \Lambda_{\text{QCD}})$$

$$\frac{d}{dt} \ln \left( \frac{\nu_{\text{Hg}^+}}{\nu_{\text{Al}^+}} \right) = (4.6 \pm 6.7) \times 10^{-17} \text{ yr}^{-1} = -2.9 \frac{d}{dt} \ln(\alpha)$$

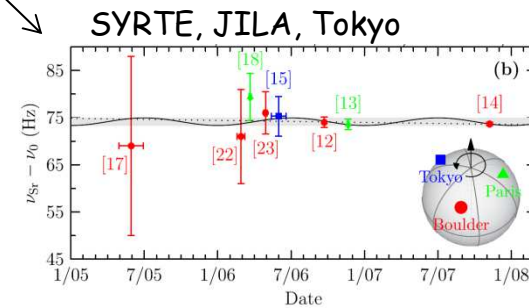
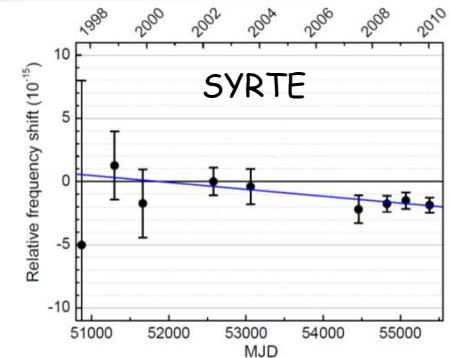

Least squares fit



$$\frac{d}{dt} \ln(\alpha) = (-0.18 \pm 0.23) \times 10^{-16} \text{ yr}^{-1}$$

$$\frac{d}{dt} \ln(m_q / \Lambda_{\text{QCD}}) = (83 \pm 48) \times 10^{-16} \text{ yr}^{-1}$$

$$\frac{d}{dt} \ln(m_e / \Lambda_{\text{QCD}}) = (1.9 \pm 4.4) \times 10^{-16} \text{ yr}^{-1}$$

INDEPENDENT OF COSMOLOGICAL MODELS

- Test as a function of gravitation potential
  - Exploiting the ellipticity of Earth orbit

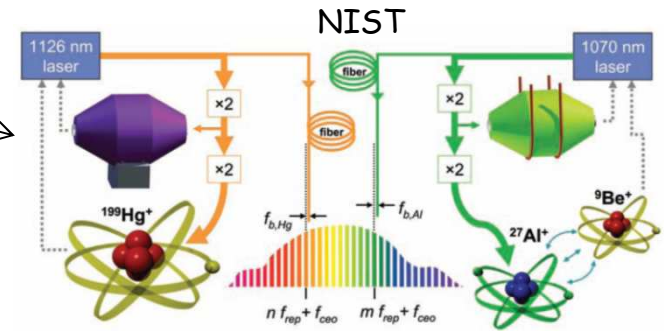

$$\frac{\Delta U(t)}{c^2} \approx - \frac{GM_{\odot}}{c^2 a} \epsilon \cos[\Omega(t - t_{\text{perihelion}})]$$

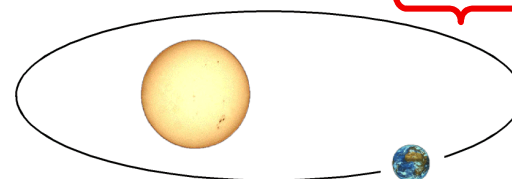

$\sim 1.6 \cdot 10^{-10}$

# A striking effect in General Relativity: the Gravitational Redshift

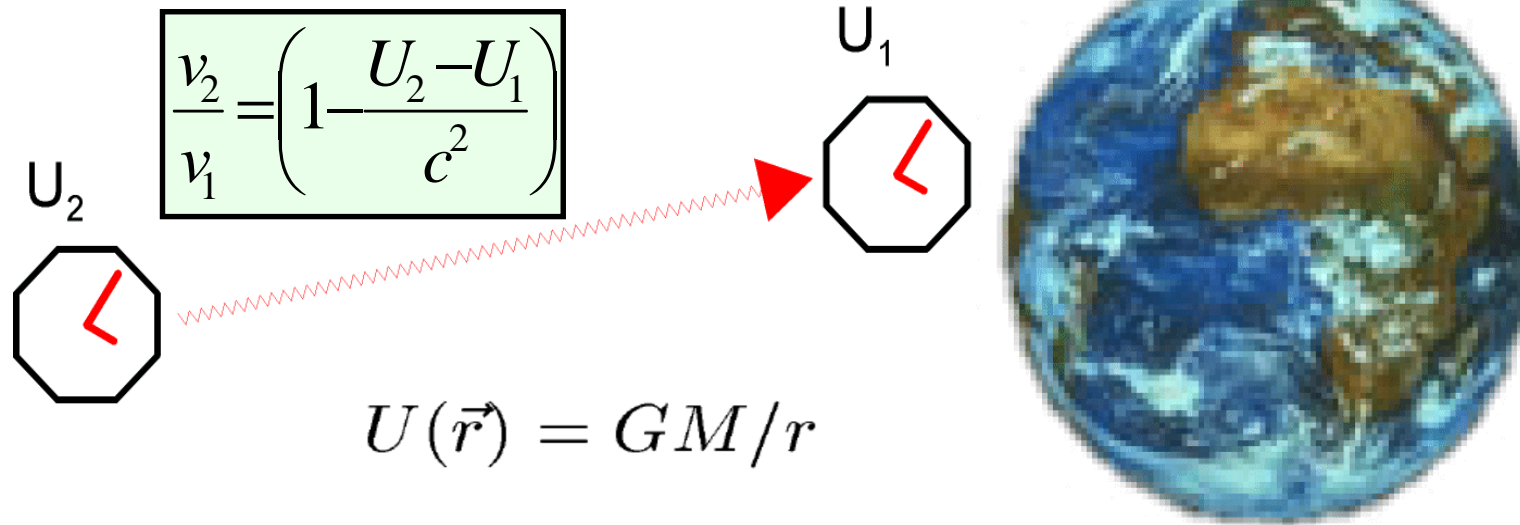

Potential of the Earth at its surface:  $7 \times 10^{-10}$

Gradient at Earth surface:  $\sim 10^{-16} \text{ m}^{-1}$

Surface to GNSS satellite ( $R=29600 \text{ km}$ ) difference:  $\sim 5.5 \times 10^{-10}$

Surface to ISS ( $h=450 \text{ km}$ ) difference:  $\sim 4.6 \times 10^{-11}$

Redshift measurement with a  $7 \times 10^{-5}$   
uncertainty: *GPA, R. Vessot et al. (1976)*

# ACES: Atomic Clocks on the ISS

Atomic Clock Ensemble in Space

*proposed by LKB and SYRTE*

*PI: C. Salomon, A. Clairon, Ph. Laurent*



PHARAO

H-MASER



CENTRE NATIONAL D'ETUDES SPATIALES

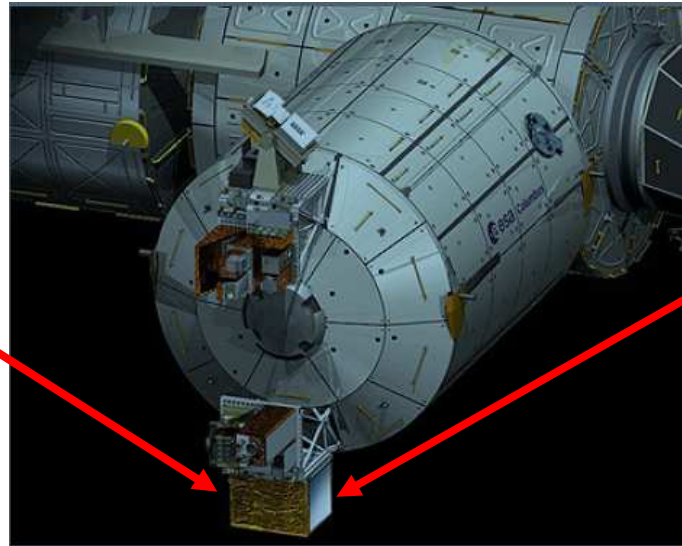

$\mu$ wave-link  
two-ways

$\mu$ wave-link  
two-ways

- A cold atom Cs standard in space
- Worldwide access
- Fundamental physics tests

Flight Model under development  
Launch: ~2015-2016 by japanese HTV  
Mission duration: 18 months

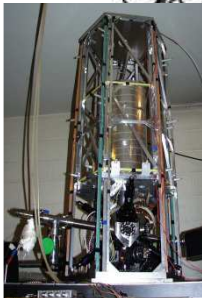



# Improvement of clock accuracy with time

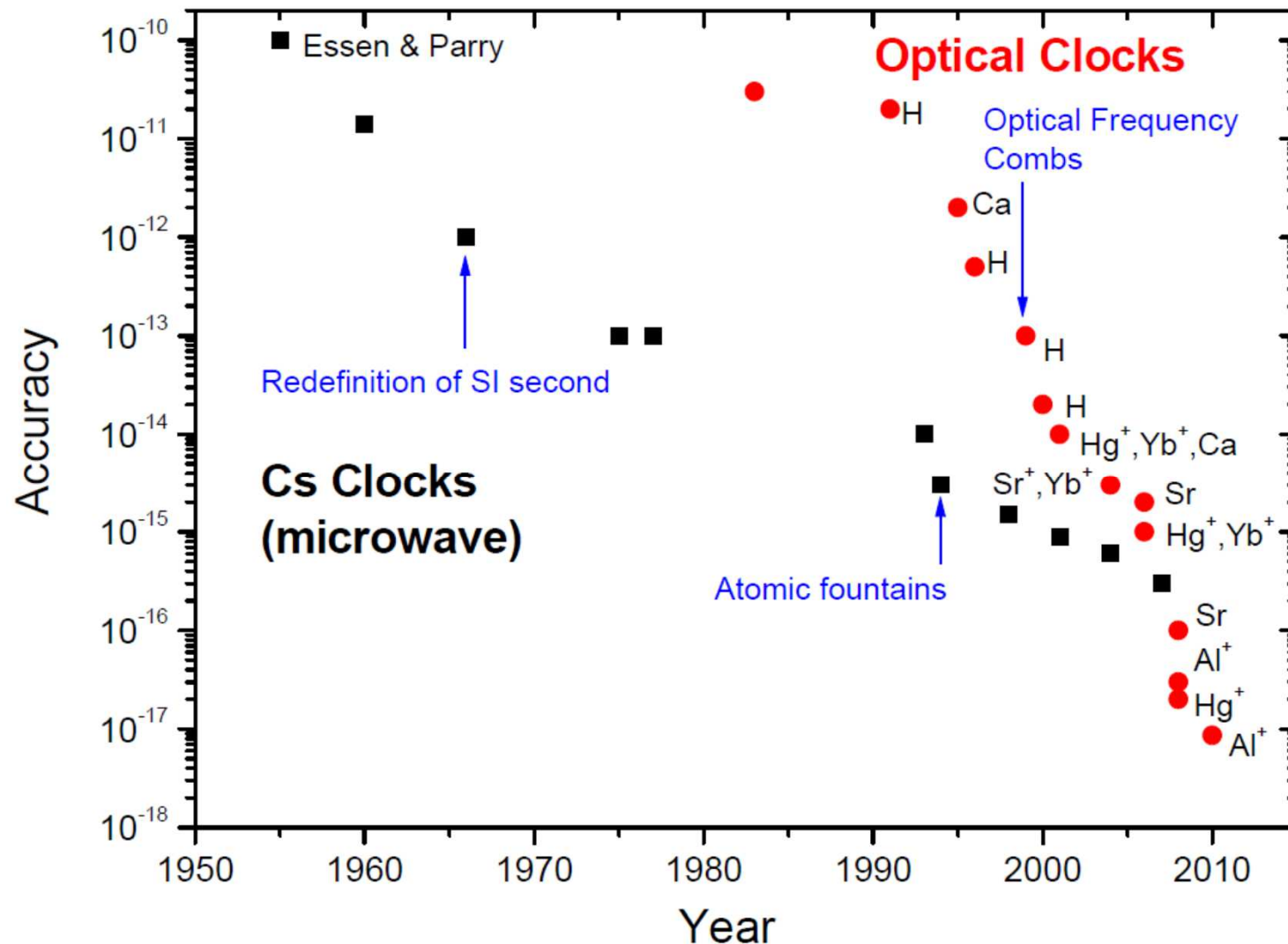

- Several optical clock transitions are recognized by BIPM as secondary representations of the SI second
- In the future, optical clocks will offer a large number of possibilities for a redefining the SI second and testing fundamental physical laws.

# Nombreuses applications des horloges atomiques

## Métrologie fondamentale

- Échelles de temps atomique, temps légal (horloge parlante 36 99, réseau hertzien, NTP, ...)
- Redéfinition des unités



## Tests de physique fondamentale

- Relativité Générale : décalage gravitationnel vers le rouge
- Invariance locale de Lorentz et de position
- Variation des constantes fondamentales



## Navigation et Positionnement

- 1ns  $\Leftrightarrow$  30 cm
- Global Navigation Satellite Systems (GNSS): GPS (USA), GLONASS (Russie), GALILEO (Europe), BEIDOU/COMPASS (Chine), GINSS (Inde)



## Synchronisation des réseaux de télécommunication

## Astronomie

- Very Long Baseline Interferometry (VLBI), Astrocomb

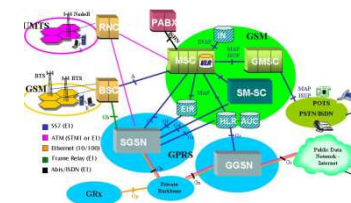

## Géophysique

- Rotation de la Terre
- Cartographie de potentiel de gravitation

