



HAL
open science

Sonder les modes optiques avec des nanosources fluorescentes

Remi Carminati

► **To cite this version:**

Remi Carminati. Sonder les modes optiques avec des nanosources fluorescentes. Master. 2011. sfo-00658676

HAL Id: sfo-00658676

<https://hal-sfo.ccsd.cnrs.fr/sfo-00658676v1>

Submitted on 10 Jan 2012

HAL is a multi-disciplinary open access archive for the deposit and dissemination of scientific research documents, whether they are published or not. The documents may come from teaching and research institutions in France or abroad, or from public or private research centers.

L'archive ouverte pluridisciplinaire **HAL**, est destinée au dépôt et à la diffusion de documents scientifiques de niveau recherche, publiés ou non, émanant des établissements d'enseignement et de recherche français ou étrangers, des laboratoires publics ou privés.

Sonder les modes optiques avec des nanosources fluorescentes

Rémi Carminati

Institut Langevin, ESPCI ParisTech, CNRS
Paris, France

remi.carminati@espci.fr

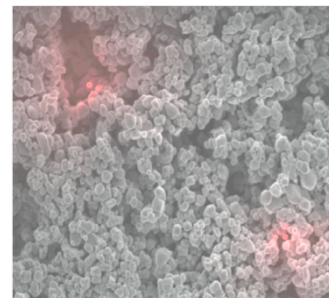
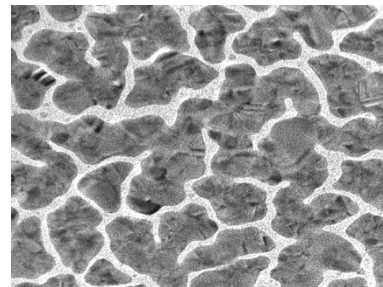

Institut Langevin @ ESPCI ParisTech



www.institut-langevin.espci.fr

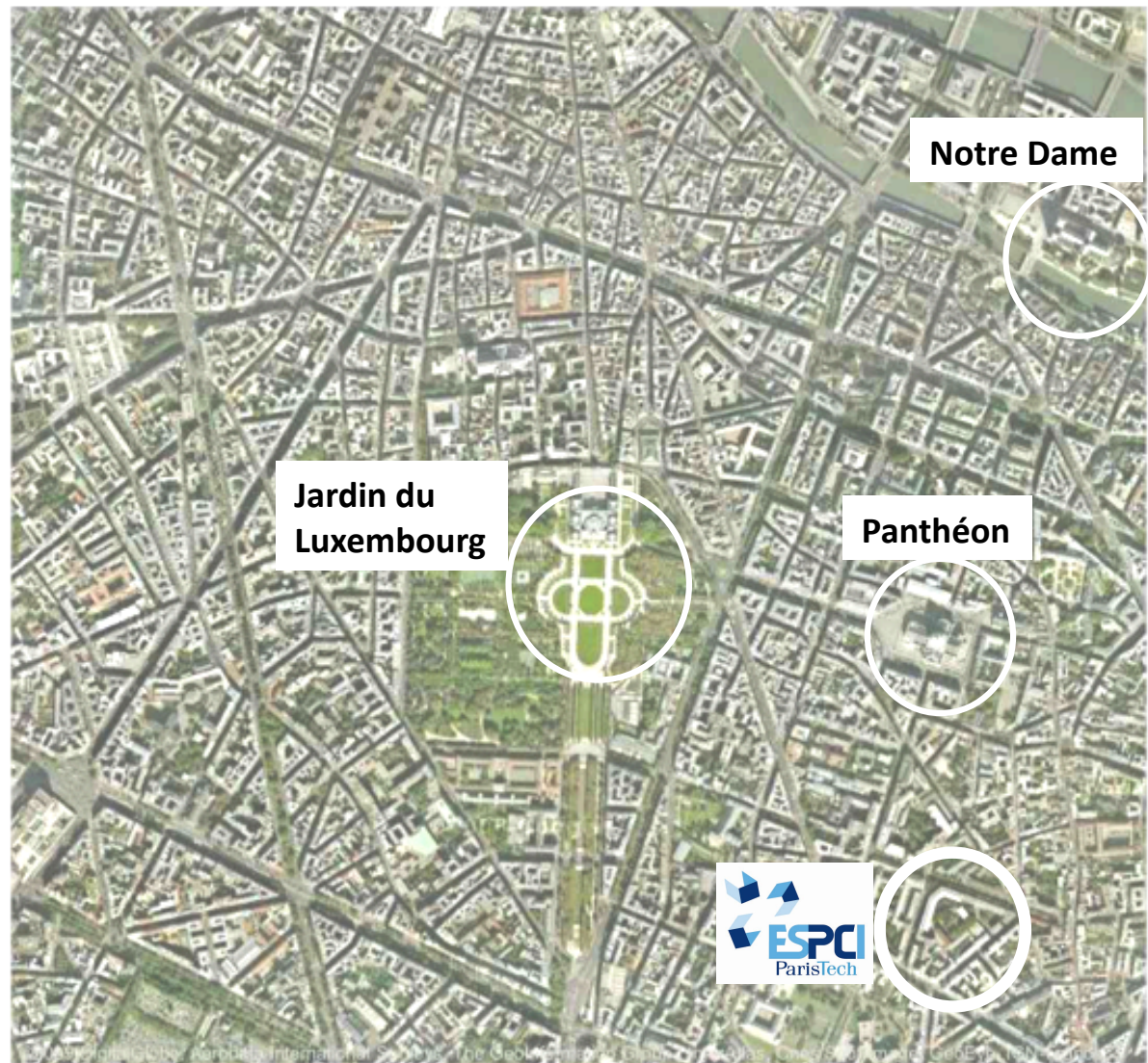



Spontaneous emission in nanostructured environments

Probing localized plasmons on disordered metallic films

Probing near-field interactions in volume disordered systems (white powders)

Fluorescence depends on environment

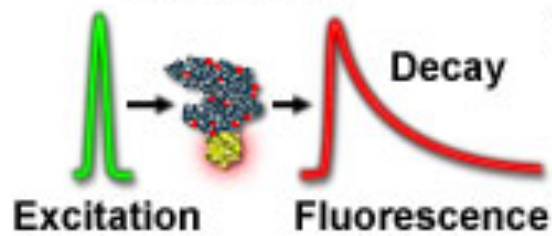

Lifetime close to a silver mirror

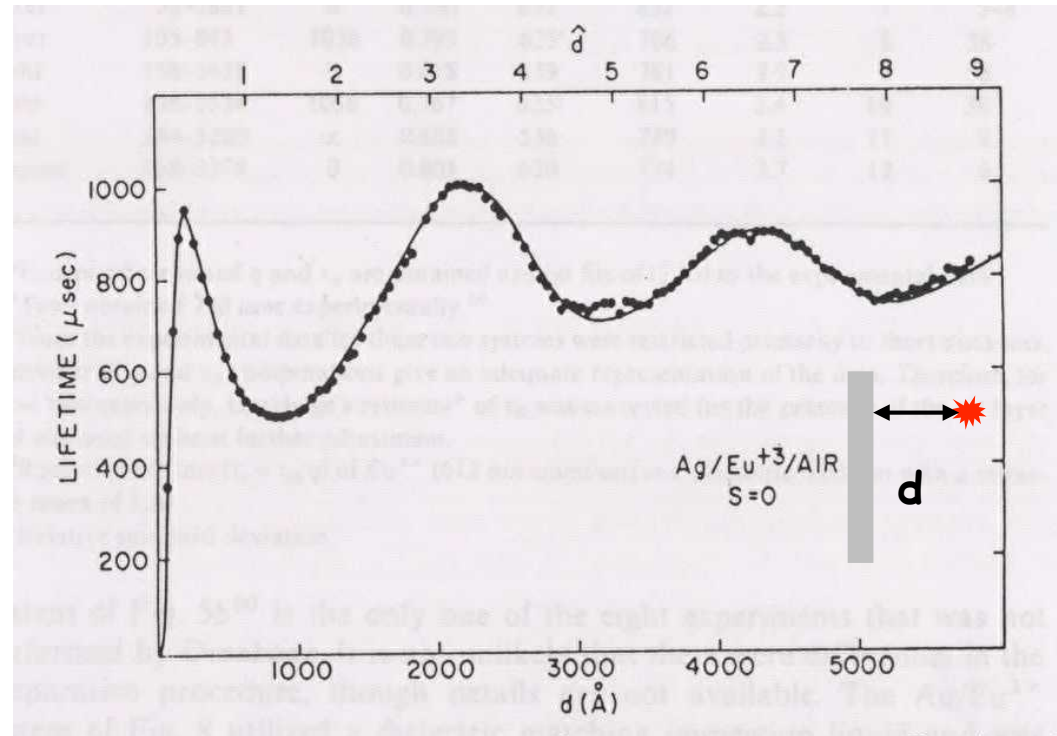

Drexhage (1970)
Chance, Prock, Silbey (1978)

How to describe the change in lifetime ?

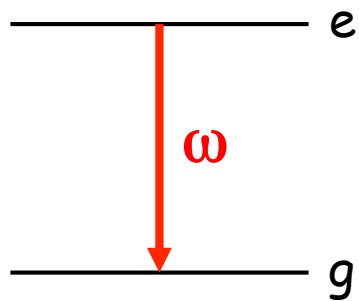

Probability of being excited at time t $P(t) \propto \exp(-\Gamma t)$

Lifetime of excited state $\tau = 1/\Gamma$

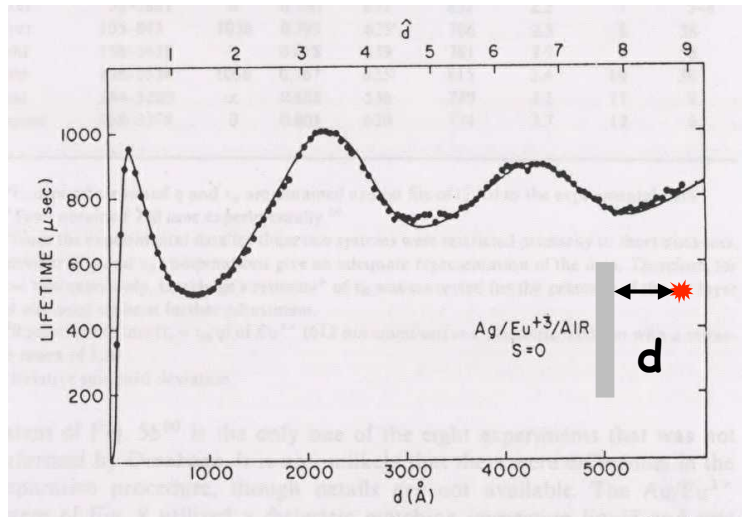

Drexhage (1970)
Chance, Prock, Silbey (1978)

Perturbation theory
(Fermi golden rule)

$$\Gamma = \frac{\pi \omega}{3\epsilon_0 \hbar} |\mathbf{p}_{ge}|^2 \rho_u(\mathbf{r}_0, \omega)$$

← Local Density of States (LDOS)

$$\frac{\Gamma}{\Gamma_0} = \text{change in the LDOS}$$

Local Density Of States (LDOS)

- Density Of States (DOS)
 - Counts modes at a given frequency

$$\rho(\omega) = \sum_n \delta(\omega - \omega_n)$$

- Local Density Of States (LDOS)
 - Counts modes at a given frequency weighted by their contribution at point \mathbf{r}

$$\rho(\omega, \mathbf{r}) = \sum_n |\mathbf{E}_n(\mathbf{r})|^2 \delta(\omega - \omega_n)$$

Purcell effect

The change in the LDOS describes the Purcell effect

E. M. Purcell "Spontaneous emission probabilities at radio frequencies" *Phys. Rev.* **69**, 681 (1946)

B10. Spontaneous Emission Probabilities at Radio Frequencies. E. M. PURCELL, *Harvard University*.—For nuclear magnetic moment transitions at radio frequencies the probability of spontaneous emission, computed from

$$A_\nu = (8\pi\nu^2/c^3)\hbar\nu(8\pi^3\mu^2/3\hbar^2) \text{ sec.}^{-1},$$

is so small that this process is not effective in bringing a spin system into thermal equilibrium with its surroundings. At 300°K, for $\nu = 10^7 \text{ sec.}^{-1}$, $\mu = 1$ nuclear magneton, the corresponding relaxation time would be 5×10^{21} seconds! However, for a system coupled to a resonant electrical circuit, the factor $8\pi\nu^2/c^3$ no longer gives correctly the number of radiation oscillators per unit volume, in unit frequency range, there being now *one* oscillator in the frequency range ν/Q associated with the circuit. The spontaneous emission probability is thereby increased, and the relaxation time reduced, by a factor $f = 3Q\lambda^3/4\pi^2V$, where V is the volume of the resonator. If a is a dimension characteristic of the circuit so that $V \sim a^3$, and if δ is the skin-depth at frequency ν , $f \sim \lambda^3/a^2\delta$. For a non-resonant circuit $f \sim \lambda^3/a^3$, and for $a < \delta$ it can be shown that $f \sim \lambda^3/a\delta^2$. If small metallic particles, of diameter 10^{-3} cm are mixed with a nuclear-magnetic medium at room temperature, spontaneous emission should establish thermal equilibrium in a time of the order of minutes, for $\nu = 10^7 \text{ sec.}^{-1}$.

For a single mode cavity

$$\frac{\Gamma}{\Gamma_0} = \text{change in LDOS}$$



$$\frac{\Gamma}{\Gamma_0} = \frac{3}{4\pi^2} \lambda^3 \frac{Q}{V}$$

(Purcell factor)

Interaction with a single nanoparticle

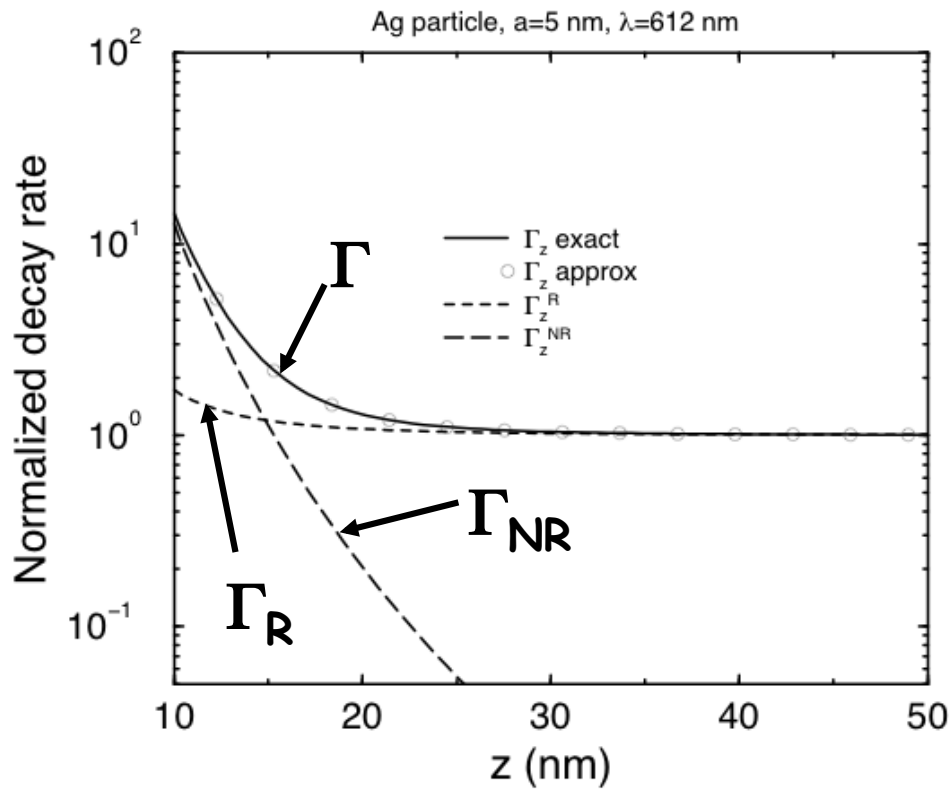
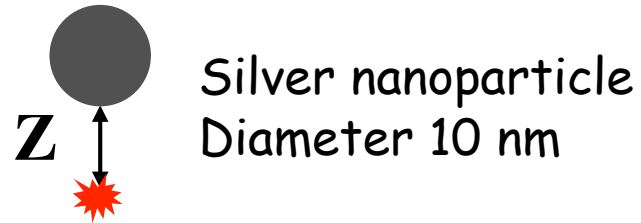

$$\Gamma = \Gamma_R + \Gamma_{NR}$$

Photon emission

Absorption

Nanoscale controlled experiments on single emitter

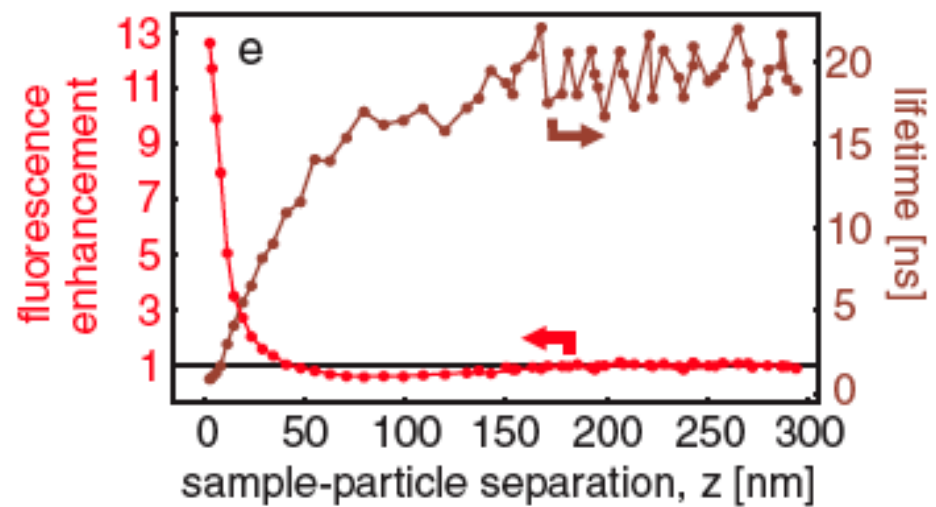
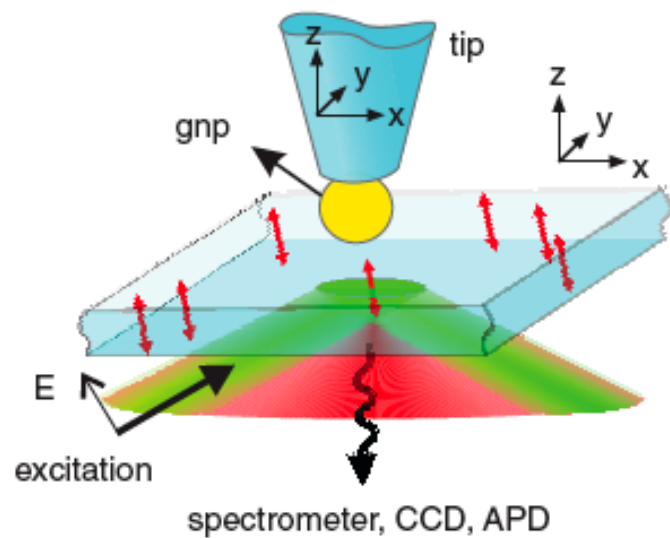

S. Kühn *et al.*, PRL 97, 017402 (2006)

Nanoparticle dimers as optical antennas



Sébastien BIDAULT
(CNRS - ESPCI)

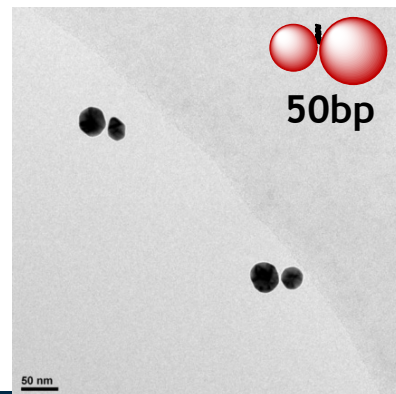
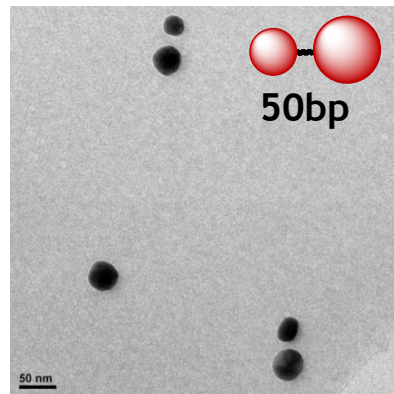
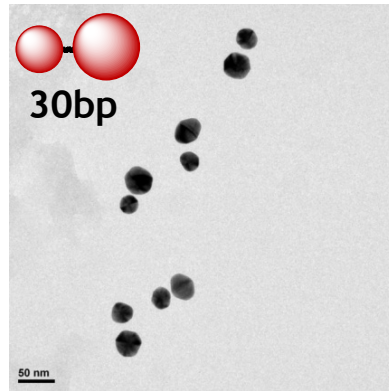

M. P. Busson *et al*,
Nano Lett. (2011)
10.1021/nl2032052

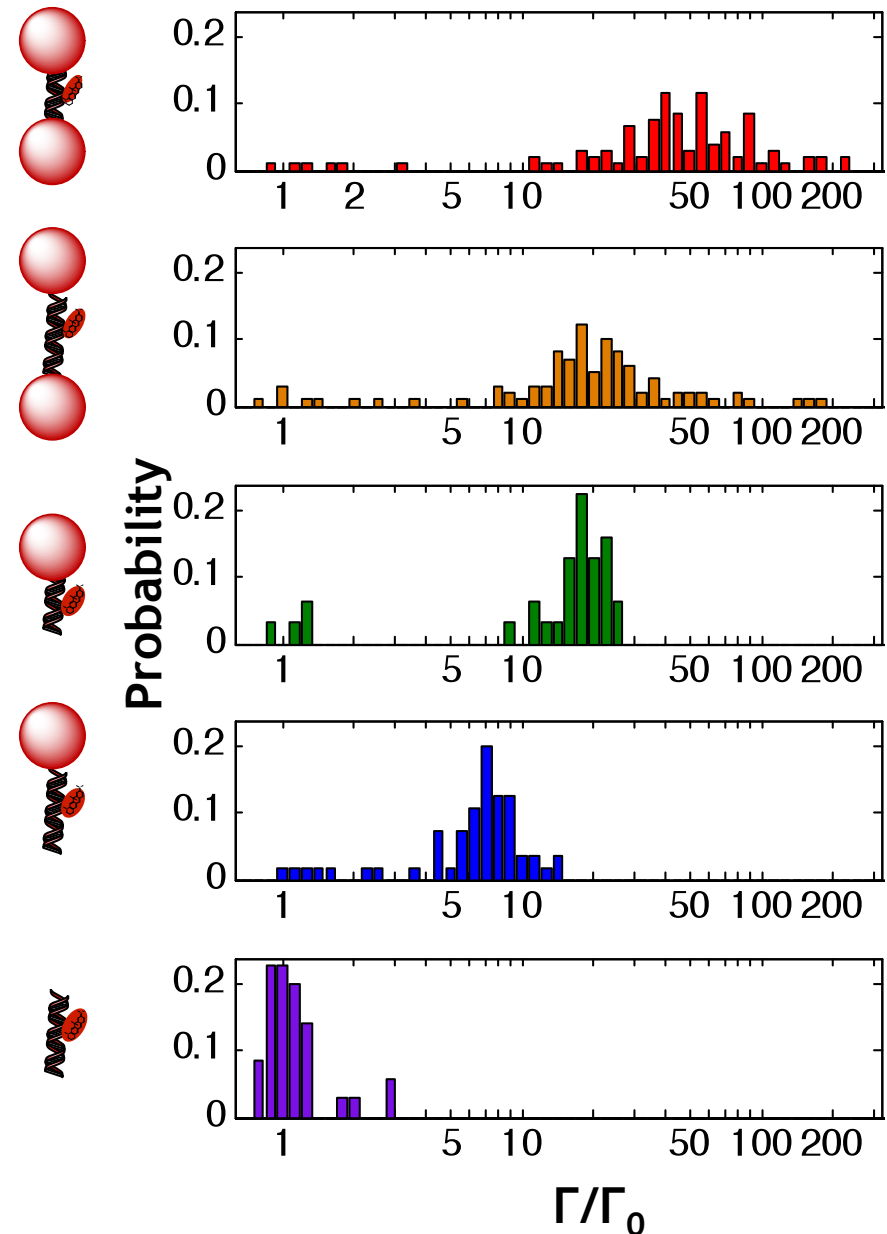



Spontaneous emission in nanostructured environments

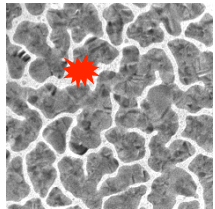

Probing localized plasmons on disordered metallic films

Probing near-field interactions in volume disordered systems (white powders)

Peculiar optical properties of disordered metal films

Semi-continuous gold films on a glass substrate



30%

49%

67%

79%

82%

89%

99%

Filling fraction

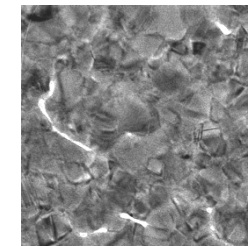
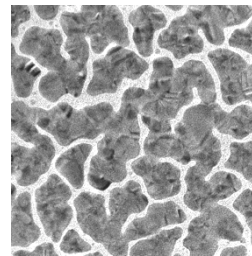
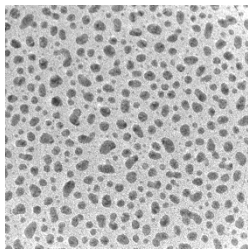

TEM images

P. Gadenne *et al.*, *J. Appl. Phys.* **66**, 3019 (1989)

V.M. Shalaev, *Nonlinear Optics of Random Media* (Springer, 2000)

Near-field intensity distribution - « hot spots »

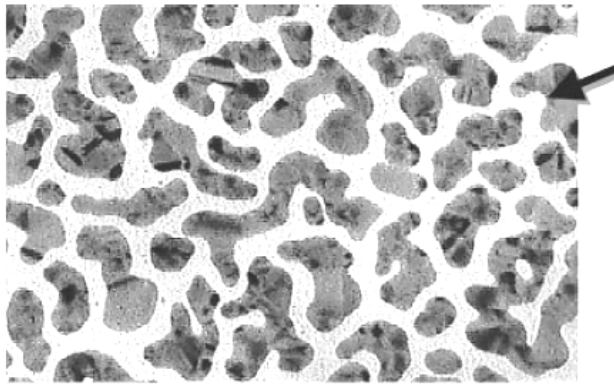

Surface (TEM image)
Gold on glass substrate

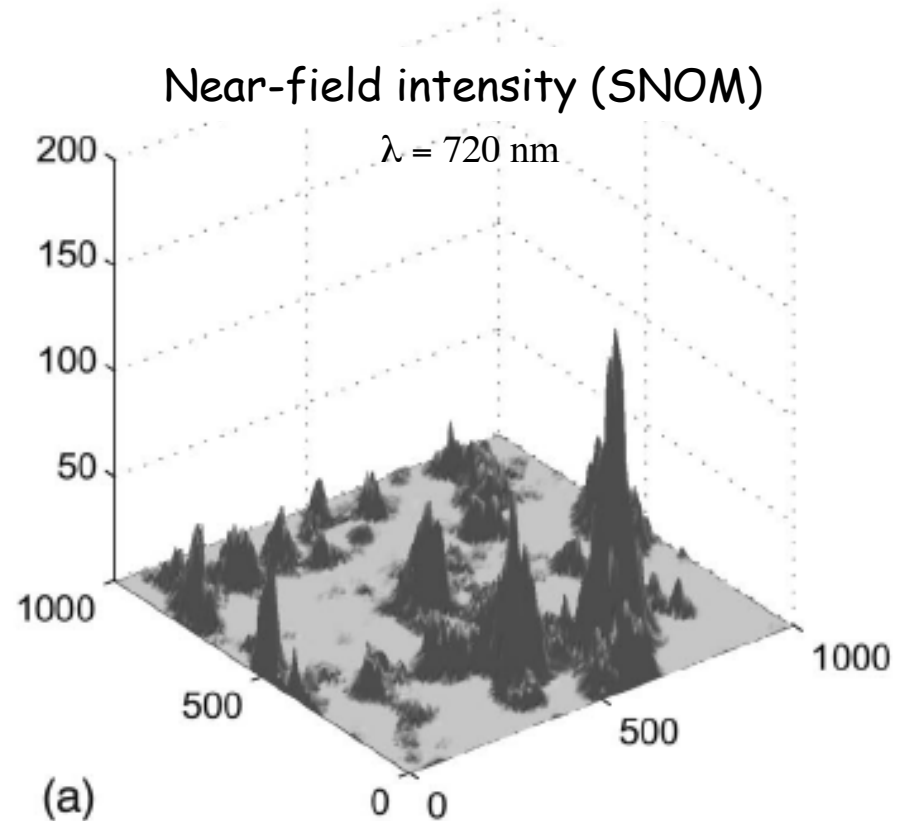

LDOS distributions on disordered metal films

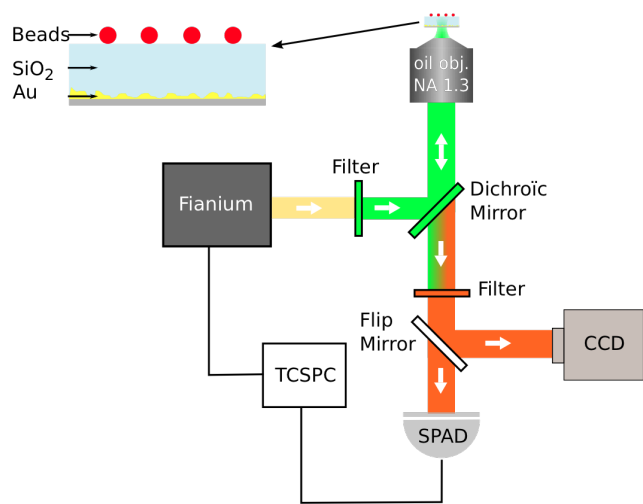

V. KRACHMALNICOFF
Post-doc



E. CASTANIE
PhD student



Y. DE WILDE
(CNRS - ESPCI)

Statistical distributions of Γ (LDOS)

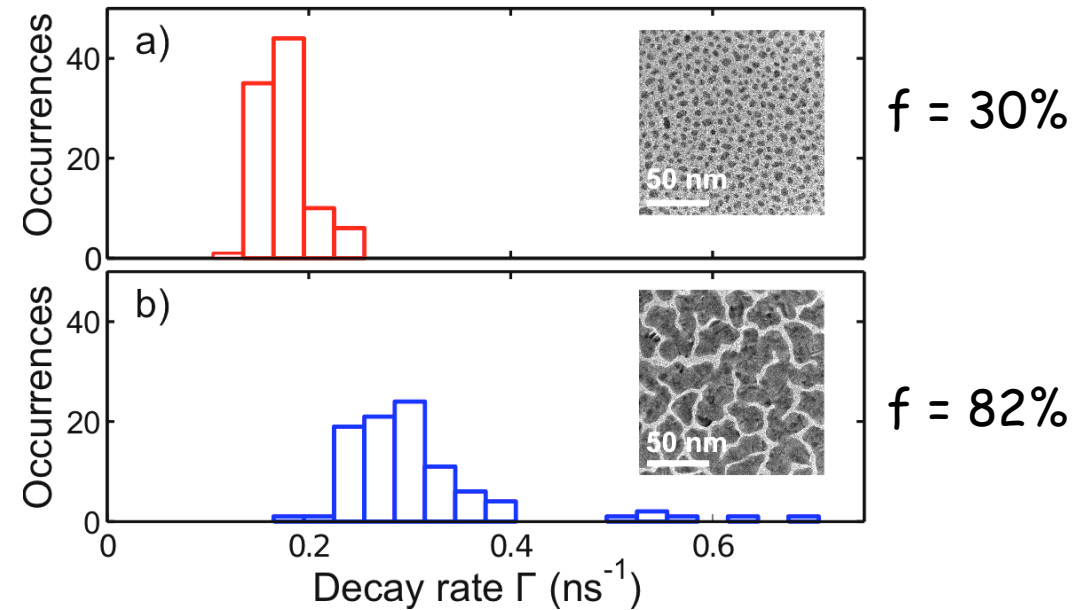
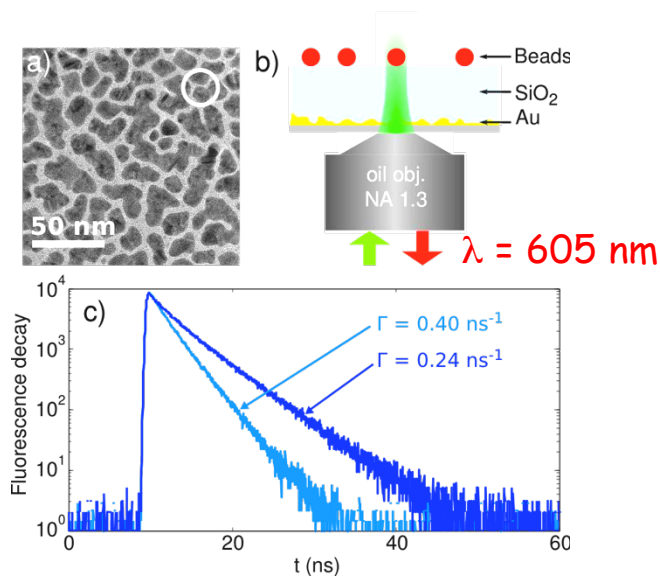

LDOS fluctuations reveals mode localization

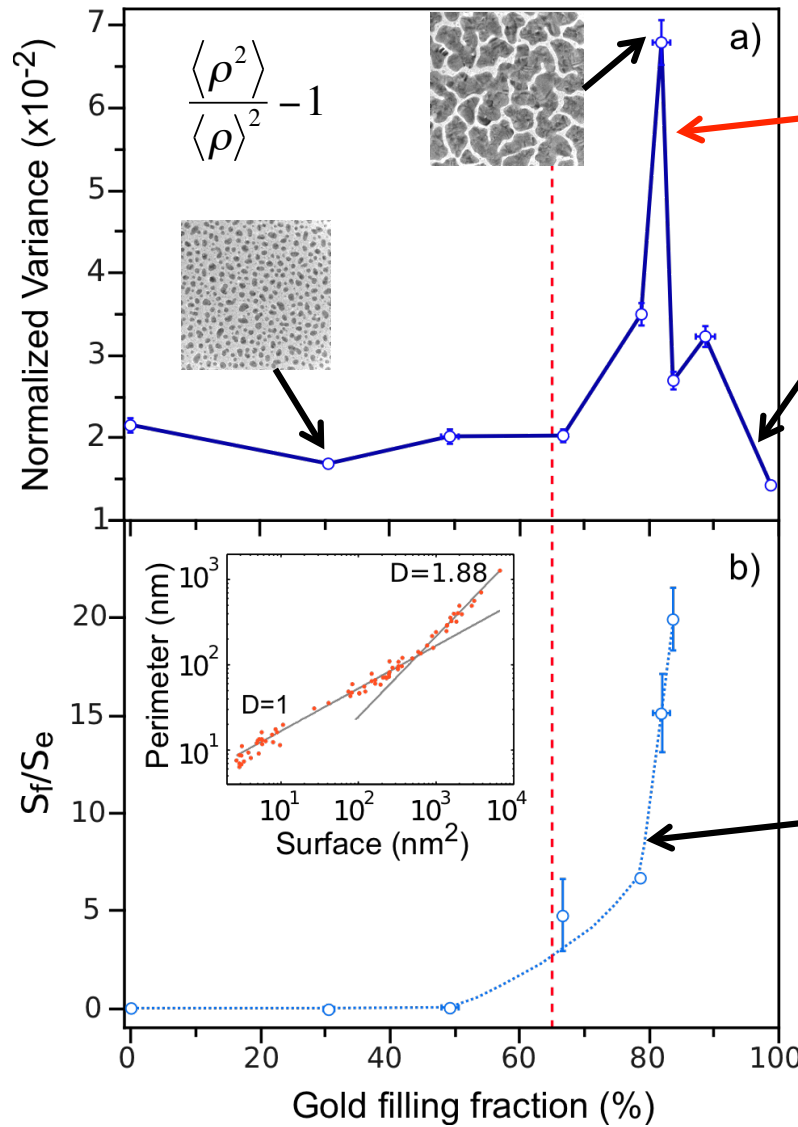

The peak in the LDOS fluctuations is the signature of localized plasmon modes

The disordered film is dominated by fractal clusters

Numerical simulation provides additional information

$$\Gamma = \Gamma_R + \Gamma_{NR}$$

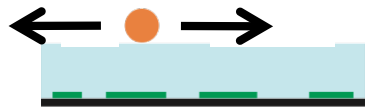

Γ^{NR}/Γ_0

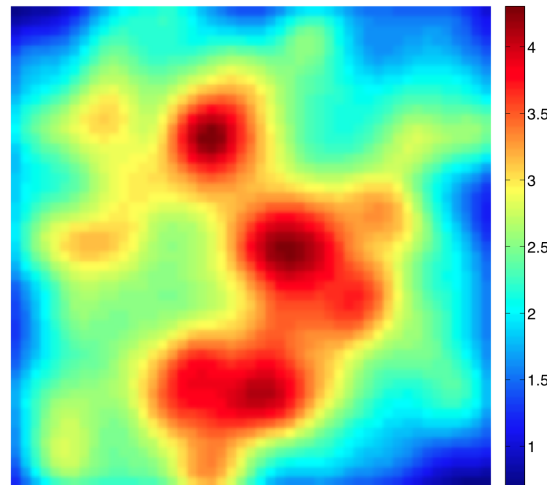

Non-radiative modes

Γ^R/Γ_0

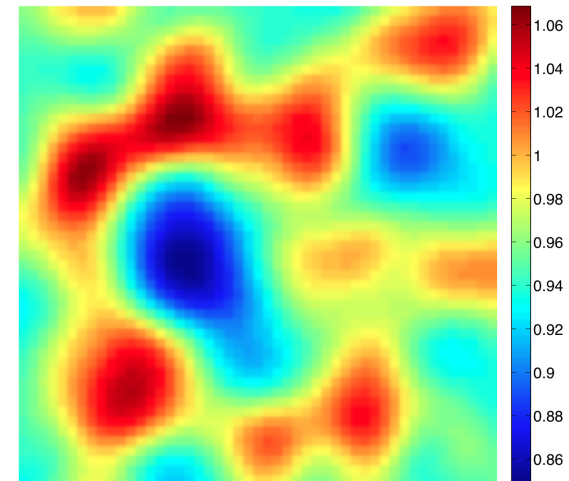

Radiative modes

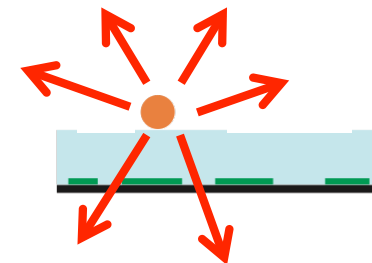



Spontaneous emission in nanostructured environments

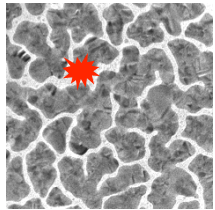

Probing localized plasmons on disordered metallic films

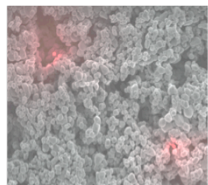

Probing near-field interactions in volume disordered systems (white powders)

Speckle patterns

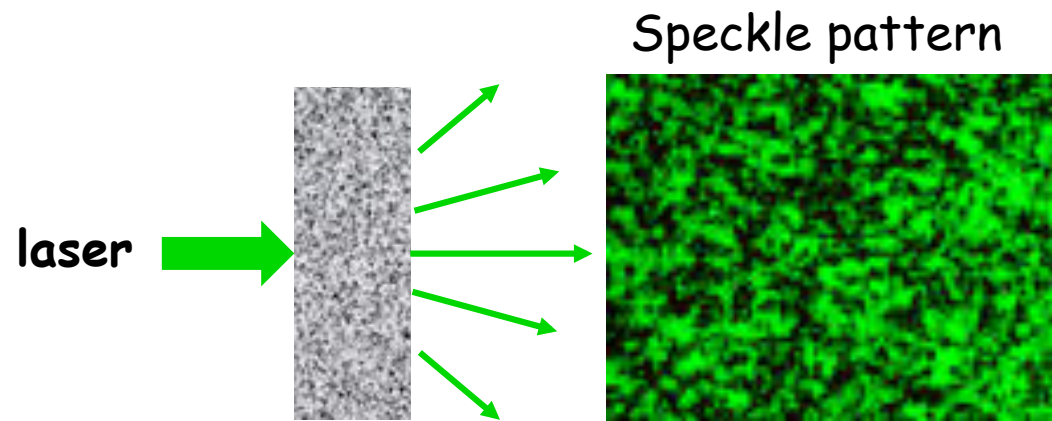

Intensity-intensity correlation

$$\langle I(r)I(r') \rangle$$

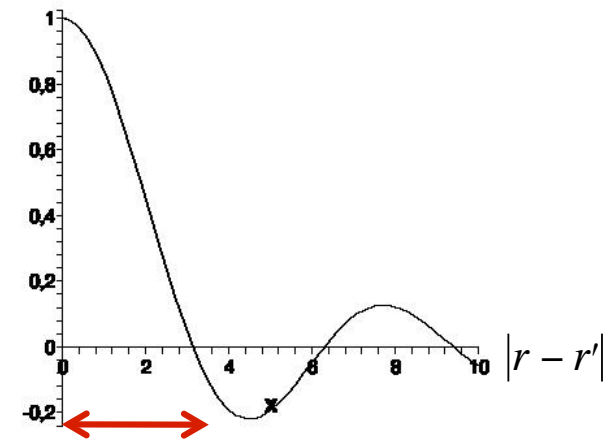

Size of speckle spot

Speckle produced by a source inside a disordered medium

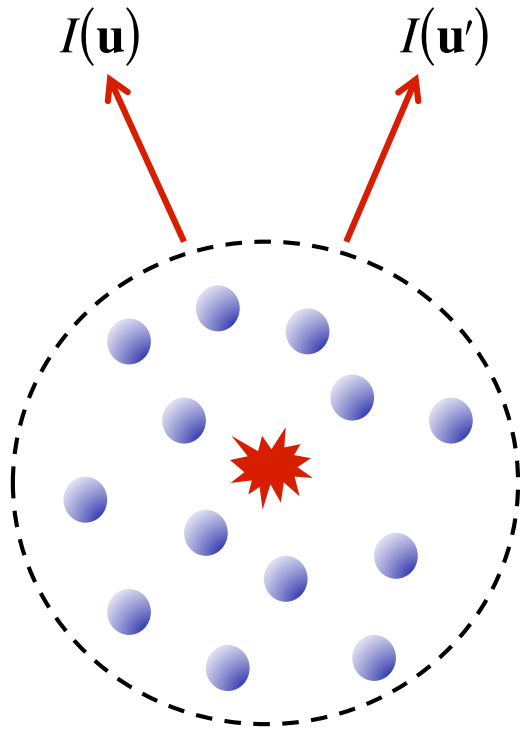

Infinite-range C_0 speckle correlation

$$C(\mathbf{u}, \mathbf{u}') = C_0 + F(\mathbf{u}, \mathbf{u}')$$

$C_0 =$ LDOS fluctuations

Shapiro, Phys. Rev. Lett. **83**, 4733 (1999)

van Tiggelen, Skipetrov, Phys. Rev. E **73**, 045601(R) (2006)

Typical « numerical experiment »

Statistical distribution of decay rate Γ (LDOS)

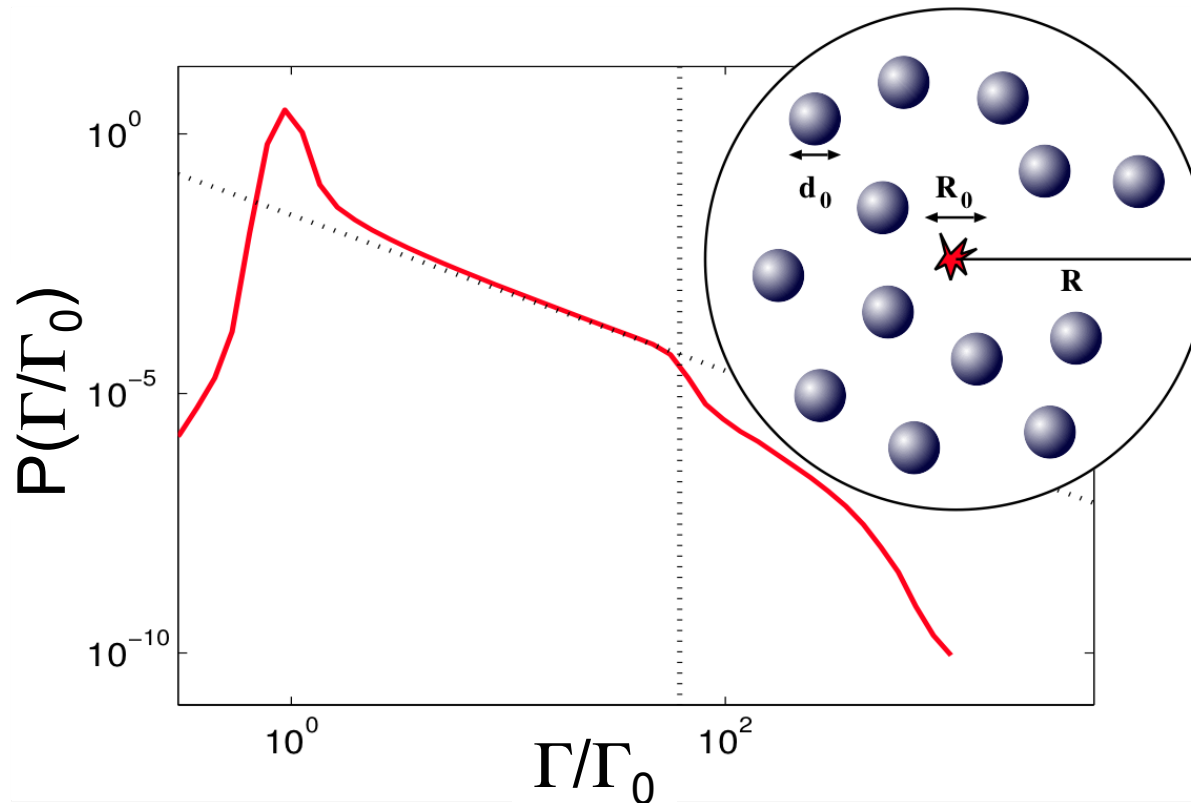

Romain PIERRAT
(CNRS - ESPCI)



Alexandre CAZE
PhD student

- Resonant point scatterers (« atoms »)
- $\lambda \approx 630$ nm
- Cluster size $R = 1.2$ μm
- Exclusion volume $R_0 = 50$ nm

Long tail: Near-field interactions

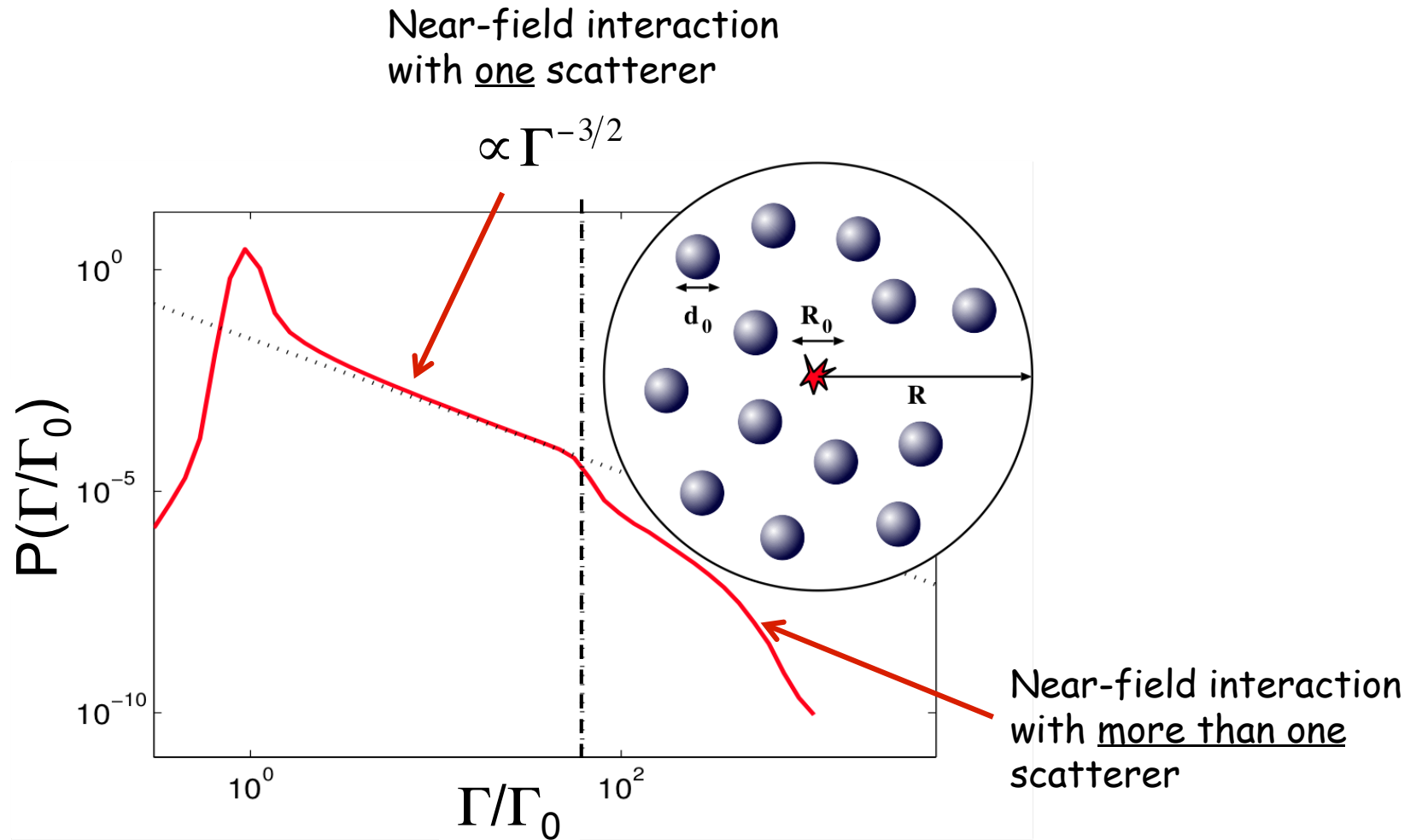

Broad - asymmetric distribution of LDOS (Purcell factor)



Riccardo SAPIENZA
Niek van HULST
(ICFO Barcelona, Spain)

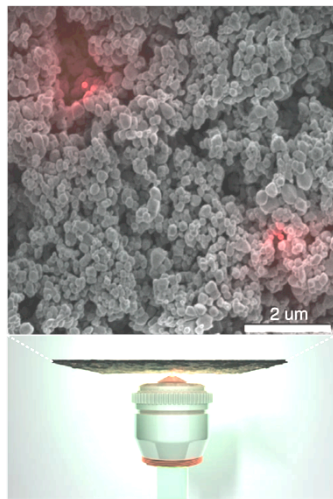

LDOS statistics probed by lifetime of nanosources (24 nm fluorescent beads)

ZnO powder
Polydisperse particles
($140 \pm 50 \text{ nm}$)

Photon mean free path

$$\ell = 0.9 \mu\text{m}$$

$$k\ell = 9.4$$

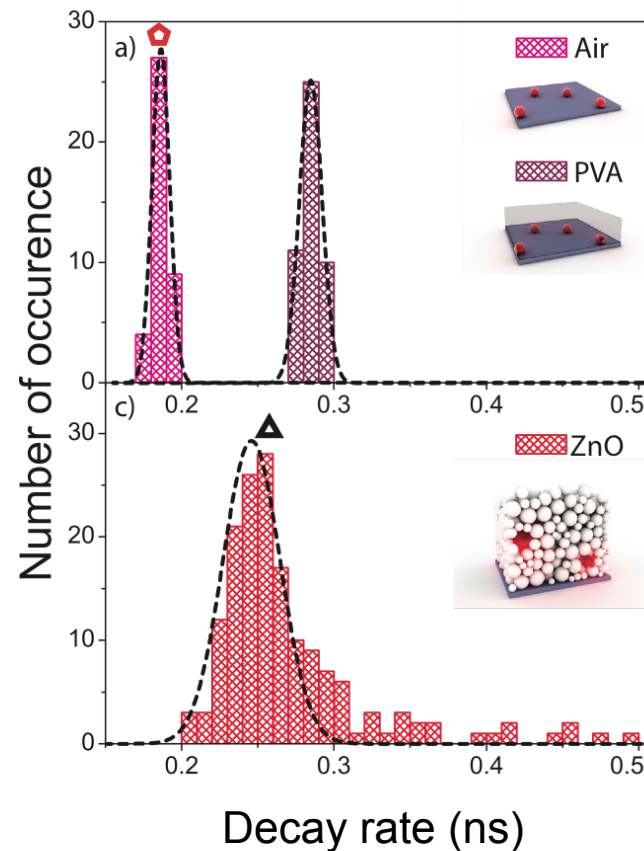

Theory

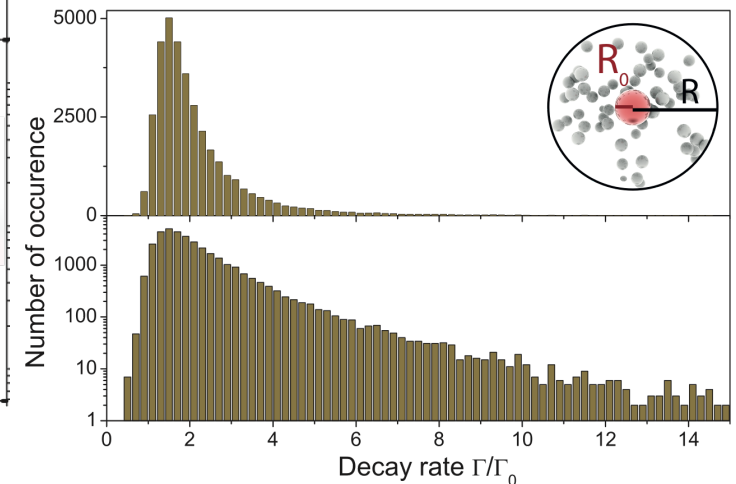

Coupling spontaneous emission with disorder: Why ?

Fluorescence imaging
in complex media

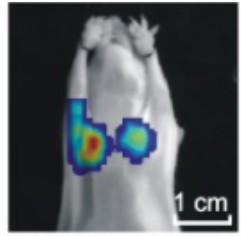

Nanophotonics - Novel materials

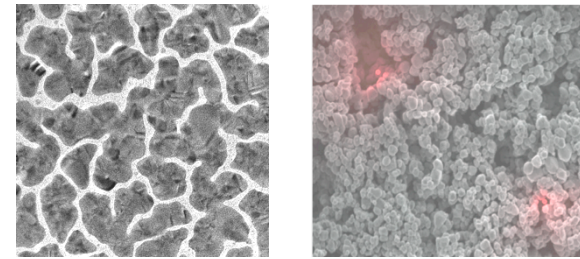

Novel light sources
(e.g. random lasers)

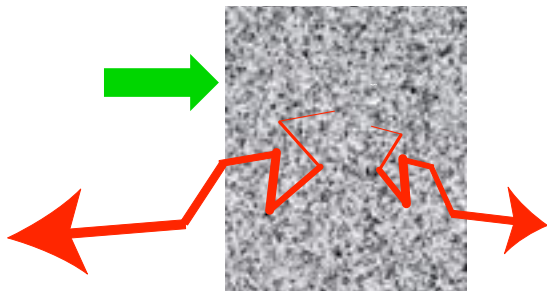

Fundamental studies of light
transport in scattering media
(e.g. probing Anderson localization)

